



# Newland

SCANNING MADE SIMPLE



## FM430 Barracuda stationary scanner user guide

# Disclaimer

© 2017-2019 Fujian Newland Auto-ID Tech. Co., Ltd. All rights reserved.

Please read through the manual carefully before using the product and operate it according to the manual. It is advised that you should keep this manual for future reference.

Do not disassemble the device or remove the seal label from the device, doing so will void the product warranty provided by Fujian Newland Auto-ID Tech. Co., Ltd.

All pictures in this manual are for reference only and actual product may differ. Regarding to the product modification and update, Fujian Newland Auto-ID Tech. Co., Ltd. reserves the right to make changes to any software or hardware to improve reliability, function, or design at any time without notice. The information contained herein is subject to change without prior notice.

The products depicted in this manual may include software copyrighted by Fujian Newland Auto-ID Tech. Co., Ltd or third party. The user, corporation or individual, shall not duplicate, in whole or in part, distribute, modify, decompile, disassemble, decode, reverse engineer, rent, transfer or sublicense such software without prior written consent from the copyright holders.

This manual is copyrighted. No part of this publication may be reproduced, distributed or used in any form without written permission from Newland.

Fujian Newland Auto-ID Tech. Co., Ltd. reserves the right to make final interpretation of the statement above.

Fujian Newland Auto-ID Tech. Co., Ltd.

3F, Building A, No.1, Rujiang West Rd., Mawei, Fuzhou, Fujian, China 350015

<http://www.newlandaidc.com>

## Revision History

Version	Description	Date
V1.0.0	Initial release.	October 27, 2017
V1.1.0	<ol style="list-style-type: none"> <li>1. Added the <b>Image Decoding Timeout</b> and <b>Read Barcode On/Off</b> features in Chapter 3.</li> <li>2. Modified the “Emulate Alt+Keypad” and “Function Key Mapping” sections; added code pages 1253-1258 in Chapter 5.</li> <li>3. Added the <b>Enable/ Disable UPC-E0/ UPC-E1</b> features in Chapter 6.</li> <li>4. Modified Chapter 7.</li> <li>5. Modified the “Data Port Pinout” section in Chapter 1.</li> </ol> <p>Note: Firmware version V1.01.017 or later is required for the new features above.</p>	March 8, 2018
V1.2.0	<ol style="list-style-type: none"> <li>1. Added the <b>Emulate Keypad with Leading Zero</b> feature in Chapter 5.</li> <li>2. Added the <b>EAN-13 Add-On Code Required, EAN-13 Beginning with 290 Add-On Code Required, EAN-13 Beginning with 378/379 Add-On Code Required, EAN-13 Beginning with 414/419 Add-On Code Required, EAN-13 Beginning with 434/439 Add-On Code Required, EAN-13 Beginning with 977 Add-On Code Required, EAN-13 Beginning with 978 Add-On Code Required, EAN-13 Beginning with 979 Add-On Code Required, and Febraban</b> features in Chapter 6.</li> </ol> <p>Note: Firmware version V1.01.019 or later is required for the new features above.</p>	April 8, 2018
V1.2.1	<ol style="list-style-type: none"> <li>1. Added the <b>Trigger Selection (Sense Mode)</b> and <b>IR Proximity Trigger Sensitivity</b> features in Chapter 3.</li> <li>2. Updated the “Caps Lock” section in Chapter 5.</li> </ol> <p>Note: Firmware version V1.01.023 or later is required for the new features above.</p>	July 19, 2018
V1.2.2	<ol style="list-style-type: none"> <li>1. Added the <b>Reread Timeout Reset</b> and <b>Make a Beeping Sound</b> features in Chapter 3.</li> <li>2. Added the <b>Code Page 932 (Japanese, Shift-JIS)</b> feature in Chapter 5.</li> <li>3. Added the <b>Surround GS1 AI's with Parentheses, EAN-8 Add-On Code Required, UPC-E Add-On Code Required, and UPC-A Add-On Code Required</b> features in Chapter 6.</li> <li>4. Added “For more information, refer to the <i>Programming Guide Based on Newland Unified Commands Set.</i>” in the “Command Programming” section in Chapter 3.</li> </ol> <p>Note: Firmware version V1.01.028 or later is required for the new features above.</p>	December 10, 2018
V1.2.3	<ol style="list-style-type: none"> <li>1. Added the <b>Barcode Pay Mode, Turn On Good Read LED, Turn On Illumination LED, Turn On Aimer, and Good Read Delay</b> features, and</li> </ol>	March 20, 2019

	<p>updated the programming barcodes for the <b>Good Read Beep Volume</b> feature in Chapter 3.</p> <p>2. Added the <b>Chinese ID Card OCR</b> and <b>China Travel Permit OCR</b> features in Chapter 6.</p> <p>Note: Firmware version V1.01.034 or later is required for the new features above.</p>	
V1.2.4	<p>1. Updated the <b>Continuous Mode</b> part in the Scan Mode section.</p> <p>2. Added the <b>Adaptive Wired Communication</b> section in Chapter 5.</p> <p>3. Added the <b>OCR symbologies</b> section in Chapter 8.</p> <p>4. Updated the VID/PID section.</p>	August 02, 2019
V1.2.5	<p>1. Added the <b>COOP 25 and Japan Post</b> sections in Chapter 6 and relative parameters in the Factory Defaults Table, AIM ID Table, Code ID and Symbology ID Number sections.</p> <p>2. Added the <b>COOP 25 and Japan Post</b> in Code ID Prefix section in Chapter 8.</p>	November 12, 2019
V1.2.6	1. Added the Datalogic Magellan Aux-RS232 section in Chapter 4.	January 21, 2020
V1.2.7	1. Updated the Datalogic Magellan Aux-RS232 barcode.	May 21, 2020
V1.2.8	1. Added the <b>Automatically Select UTF-8 or Code Page</b> barcode in PDF417, QR Code, Data Matrix and Aztec sections.	June 17, 2020

# Table of Contents

<b>Revision History .....</b>	<b>- 3 -</b>
<b>Preface .....</b>	<b>1</b>
Introduction .....	1
Chapter Description .....	1
Explanation of Icons .....	2
<b>Chapter 1 Getting Started .....</b>	<b>3</b>
Introduction .....	3
Features of the FM430 .....	3
Unpacking .....	3
FM430 Scanner .....	4
Data Port Pinout .....	5
Dimensions (unit: mm) .....	6
IR Triggering Range .....	7
Optics .....	8
Connecting the FM430 to a Host Device .....	9
Using USB Cable .....	10
Using RS-232 Cable .....	11
Scanning Instructions .....	12
Maintenance .....	12
<b>Chapter 2 EasySet .....</b>	<b>13</b>
<b>Chapter 3 System Settings .....</b>	<b>14</b>
Introduction .....	14
Barcode Programming .....	14
Command Programming .....	14
EasySet Programming .....	14
Programming Barcode/ Programming Command/Function .....	15
Use of Programming Command .....	16
Command Syntax .....	16
Query Commands .....	16
Responses .....	17
Examples .....	17
Use of Programming Barcodes .....	18
Illumination .....	19
Aiming .....	20

Good Read LED.....	20
Good Read LED Duration .....	21
Power On Beep.....	22
Good Read Beep .....	22
Good Read Beep Duration.....	23
Good Read Beep Frequency .....	24
Good Read Beep Volume .....	25
Scan Mode .....	26
Decode Session Timeout .....	27
Image Stabilization Timeout (Sense Mode).....	28
Reread Timeout.....	29
Image Decoding Timeout .....	30
Good Read Delay.....	31
Trigger Selection (Sense Mode).....	32
Image Change Trigger Sensitivity .....	33
IR Proximity Trigger Sensitivity .....	34
Trigger Commands.....	35
Modify Start Scanning Command .....	35
Modify Stop Scanning Command.....	36
Scanning Preference.....	37
Read Barcode On/Off.....	38
Make a Beeping Sound.....	38
Turn On Good Read LED.....	38
Turn On Illumination LED .....	39
Turn On Aimer .....	39
Decode Area .....	40
Image Flipping.....	42
Bad Read Message.....	43
Set Bad Read Message .....	43
Default Settings.....	44
Factory Defaults.....	44
Custom Defaults .....	44
Query Product Information .....	45
Query Product Name .....	45
Query Firmware Version .....	45
Query Decoder Version.....	46
Query Hardware Version.....	46
Query Product Serial Number .....	46

Query Manufacturing Date .....	47
Query OEM Serial Number .....	47
Query Data Formatter Version .....	47
<b>Chapter 4 RS-232 Interface.....</b>	<b>48</b>
Introduction .....	48
Baud Rate .....	49
Parity Check.....	50
Data Bit .....	51
Stop Bit .....	51
Hardware Auto Flow Control .....	52
Datalogic Magellan Aux-RS232.....	53
<b>Chapter 5 USB Interface .....</b>	<b>54</b>
Introduction .....	54
USB HID Keyboard .....	55
USB Country Keyboard Types .....	56
Beep on Unknown Character .....	60
Emulate ALT+Keypad .....	61
Code Page .....	62
Unicode Encoding .....	64
Emulate Keypad with Leading Zero .....	64
Function Key Mapping .....	65
ASCII Function Key Mapping Table .....	66
ASCII Function Key Mapping Table (Continued) .....	67
Inter-Keystroke Delay .....	68
Caps Lock.....	69
Convert Case .....	70
Emulate Numeric Keypad .....	71
Fast Mode .....	73
Polling Rate.....	74
USB CDC .....	76
HID POS (POS HID Barcode Scanner).....	77
Introduction .....	77
Access the Scanner with Your Program .....	77
Acquire Scanned Data .....	78
Send Command to the Scanner.....	78
IBM SurePOS (Tabletop).....	79
IBM SurePOS (Handheld) .....	79

VID/PID .....	79
Adaptive Wired Communication .....	80
<b>Chapter 6 Symbologies.....</b>	<b>81</b>
Introduction .....	81
Global Settings.....	81
Enable/Disable All Symbologies.....	81
Enable/Disable 1D Symbologies.....	81
Enable/Disable 2D Symbologies.....	82
Enable/Disable Postal Symbologies .....	82
1D Twin Code .....	83
Surround GS1 Application Identifiers (AI's) with Parentheses.....	84
Code 128 .....	85
Restore Factory Defaults .....	85
Enable/Disable Code 128 .....	85
Set Length Range for Code 128 .....	86
EAN-8 .....	87
Restore Factory Defaults .....	87
Enable/Disable EAN-8 .....	87
Transmit Check Character .....	87
2-Digit Add-On Code.....	88
5-Digit Add-On Code.....	89
Add-On Code Required .....	90
Convert EAN-8 to EAN-13 .....	90
EAN-13 .....	91
Restore Factory Defaults .....	91
Enable/Disable EAN-13 .....	91
Transmit Check Character .....	92
2-Digit Add-On Code.....	92
5-Digit Add-On Code.....	93
Add-On Code Required .....	93
EAN-13 Beginning with 290 Add-On Code Required .....	94
EAN-13 Beginning with 378/379 Add-On Code Required .....	94
EAN-13 Beginning with 414/419 Add-On Code Required .....	95
EAN-13 Beginning with 434/439 Add-On Code Required .....	95
EAN-13 Beginning with 977 Add-On Code Required .....	96
EAN-13 Beginning with 978 Add-On Code Required .....	96
EAN-13 Beginning with 979 Add-On Code Required .....	97



UPC-E.....	98
Restore Factory Defaults .....	98
Enable/Disable UPC-E.....	98
Transmit Check Character .....	99
2-Digit Add-On Code.....	99
5-Digit Add-On Code.....	100
Add-On Code Required .....	100
Transmit Preamble Character .....	101
Convert UPC-E to UPC-A .....	101
UPC-A.....	102
Restore Factory Defaults .....	102
Enable/Disable UPC-A.....	102
Transmit Check Character .....	102
2-Digit Add-On Code.....	103
5-Digit Add-On Code.....	104
Add-On Code Required .....	105
Transmit Preamble Character .....	105
Coupon .....	106
UPC-A/EAN-13 with Extended Coupon Code.....	106
Coupon GS1 Databar Output.....	107
Interleaved 2 of 5 .....	108
Restore Factory Defaults .....	108
Enable/Disable Interleaved 2 of 5 .....	108
Set Length Range for Interleaved 2 of 5 .....	109
Check Character Verification.....	110
Febraban.....	111
Disable/Enable Febraban.....	111
Transmit Delay per Character .....	111
Transmit Delay per 12 Characters .....	114
ITF-14 .....	116
Restore Factory Defaults .....	116
Enable/Disable ITF-14 .....	116
ITF-6 .....	117
Restore Factory Defaults .....	117
Enable/Disable ITF-6 .....	117
Matrix 2 of 5 .....	118
Restore Factory Defaults .....	118
Enable/Disable Matrix 2 of 5 .....	118

Set Length Range for Matrix 2 of 5 .....	119
Check Character Verification.....	120
Code 39 .....	121
Restore Factory Defaults .....	121
Enable/Disable Code 39 .....	121
Set Length Range for Code 39 .....	122
Check Character Verification.....	123
Transmit Start/Stop Character.....	124
Enable/Disable Code 39 Full ASCII .....	124
Enable/Disable Code 32 (Italian Pharma Code) .....	125
Code 32 Prefix .....	125
Transmit Code 32 Start/Stop Character .....	126
Transmit Code 32 Check Character .....	126
Codabar .....	127
Restore Factory Defaults .....	127
Enable/Disable Codabar .....	127
Set Length Range for Codabar .....	128
Check Character Verification.....	129
Start/Stop Character .....	130
Code 93 .....	131
Restore Factory Defaults .....	131
Enable/Disable Code 93 .....	131
Set Length Range for Code 93 .....	132
Check Character Verification.....	133
China Post 25.....	134
Restore Factory Defaults .....	134
Enable/Disable China Post 25 .....	134
Set Length Range for China Post 25 .....	135
Check Character Verification.....	136
GS1-128 (UCC/EAN-128) .....	137
Restore Factory Defaults .....	137
Enable/Disable GS1-128.....	137
Set Length Range for GS1-128.....	138
GS1 Databar (RSS) .....	139
Restore Factory Defaults .....	139
Enable/Disable GS1 Databar .....	139
Transmit Application Identifier "01" .....	140
GS1 Composite (EAN-UCC Composite) .....	140

Restore Factory Defaults .....	140
Enable/Disable GS1 Composite.....	140
Enable/Disable UPC/EAN Composite .....	141
Code 11 .....	141
Restore Factory Defaults .....	141
Enable/Disable Code 11.....	141
Set Length Range for Code 11 .....	142
Check Character Verification.....	143
Transmit Check Character .....	144
ISBN.....	145
Restore Factory Defaults .....	145
Enable/Disable ISBN .....	145
Set ISBN Format.....	146
ISSN.....	147
Restore Factory Defaults .....	147
Enable/Disable ISSN .....	147
Industrial 25.....	148
Restore Factory Defaults .....	148
Enable/Disable Industrial 25 .....	148
Set Length Range for Industrial 25 .....	149
Check Character Verification.....	150
Standard 25.....	151
Restore Factory Defaults .....	151
Enable/Disable Standard 25 .....	151
Set Length Range for Standard 25 .....	152
Check Character Verification.....	153
Plessey .....	154
Restore Factory Defaults .....	154
Enable/Disable Plessey .....	154
Set Length Range for Plessey .....	155
Check Character Verification.....	156
MSI-Plessey.....	157
Restore Factory Defaults .....	157
Enable/Disable MSI-Plessey.....	157
Set Length Range for MSI-Plessey.....	158
Check Character Verification.....	159
Transmit Check Character .....	160
AIM 128.....	161

Restore Factory Defaults .....	161
Enable/Disable AIM 128.....	161
Set Length Range for AIM 128.....	162
ISBT 128 .....	163
Restore Factory Defaults .....	163
Enable/Disable ISBT 128.....	163
Code 49 .....	164
Restore Factory Defaults .....	164
Enable/Disable Code 49 .....	164
Set Length Range for Code 49 .....	165
Code 16K .....	166
Restore Factory Defaults .....	166
Enable/Disable Code 16K.....	166
Set Length Range for Code 16K.....	167
COOP 25.....	168
Restore Factory Defaults .....	168
Enable/Disable COOP 25 .....	168
Set Length Range for Code 16K.....	169
Check Character Verification.....	170
PDF417 .....	171
Restore Factory Defaults .....	171
Enable/Disable PDF417.....	171
Set Length Range for PDF417 .....	172
PDF417 Twin Code .....	173
PDF417 Inverse .....	174
Character Encoding .....	174
PDF417 ECI Output .....	175
Micro PDF417 .....	176
Restore Factory Defaults .....	176
Enable/Disable Micro PDF417 .....	176
Set Length Range for Micro PDF417 .....	177
QR Code .....	178
Restore Factory Defaults .....	178
Enable/Disable QR Code .....	178
Set Length Range for QR Code .....	179
QR Twin Code.....	180
QR Inverse.....	181
Character Encoding .....	181

QR ECI Output.....	182
Micro QR Code .....	183
Restore Factory Defaults .....	183
Enable/Disable Micro QR.....	183
Set Length Range for Micro QR.....	184
Aztec .....	185
Restore Factory Defaults .....	185
Enable/Disable Aztec Code.....	185
Set Length Range for Aztec Code.....	186
Read Multi-barcodes on an Image .....	187
Set the Number of Barcodes.....	188
Character Encoding .....	189
Aztec ECI Output .....	189
Data Matrix.....	190
Restore Factory Defaults .....	190
Enable/Disable Data Matrix.....	190
Set Length Range for Data Matrix.....	191
Data Matrix Twin Code.....	192
Rectangular Barcode .....	193
Data Matrix Inverse.....	193
Character Encoding .....	194
Data Matrix ECI Output.....	194
Maxicode.....	195
Restore Factory Defaults .....	195
Enable/Disable Maxicode.....	195
Set Length Range for Maxicode.....	196
Chinese Sensible Code.....	197
Restore Factory Defaults .....	197
Enable/Disable Chinese Sensible Code .....	197
Set Length Range for Chinese Sensible Code.....	198
Chinese Sensible Twin Code .....	199
Chinese Sensible Code Inverse.....	200
GM Code.....	201
Restore Factory Defaults .....	201
Enable/Disable GM .....	201
Set Length Range for GM .....	202
Code One.....	203
Restore Factory Defaults .....	203

Enable/Disable Code One.....	203
Set Length Range for Code One.....	204
USPS Postnet .....	205
Restore Factory Defaults .....	205
Enable/Disable USPS Postnet .....	205
Transmit Check Character .....	205
USPS Intelligent Mail .....	206
Restore Factory Defaults .....	206
Enable/Disable USPS Intelligent Mail .....	206
Royal Mail .....	207
Restore Factory Defaults .....	207
Enable/Disable Royal Mail .....	207
USPS Planet .....	208
Restore Factory Defaults .....	208
Enable/Disable USPS Planet .....	208
Transmit Check Character .....	208
KIX Post .....	209
Restore Factory Defaults .....	209
Enable/Disable KIX Post .....	209
Australian Postal .....	210
Restore Factory Defaults .....	210
Enable/Disable Australian Postal .....	210
Japan Post .....	211
Restore Factory Defaults .....	211
Enable/Disable Japan Post .....	211
Specific OCR-B .....	212
Restore Factory Defaults .....	212
Enable/Disable Specific OCR-B .....	212
Chinese ID Card OCR.....	213
Restore Factory Defaults .....	213
Enable/Disable Chinese ID Card OCR .....	213
Passport OCR .....	214
Restore Factory Defaults .....	214
Enable/Disable Passport OCR .....	214
China Travel Permit OCR.....	215
Restore Factory Defaults .....	215
Enable/Disable China Travel Permit OCR.....	215

<b>Chapter 7 Data Formatter .....</b>	<b>216</b>
Introduction .....	216
Add a Data Format .....	216
Programming with Barcodes .....	216
Programming with Serial Commands .....	219
Enable/Disable Data Formatter .....	220
Non-Match Error Beep .....	221
Data Format Selection .....	222
Change Data Format for a Single Scan .....	223
Clear Data Format .....	224
Query Data Formats .....	224
Formatter Command Type 6 .....	225
Send Commands .....	225
Move Commands .....	228
Search Commands .....	230
Miscellaneous Commands .....	233
<b>Chapter 8 Prefix &amp; Suffix .....</b>	<b>239</b>
Introduction .....	239
Global Settings .....	240
Enable/Disable All Prefixes/Suffixes .....	240
Prefix Sequence .....	240
Custom Prefix .....	241
Enable/Disable Custom Prefix .....	241
Set Custom Prefix .....	241
AIM ID Prefix .....	242
Code ID Prefix .....	243
Restore All Default Code IDs .....	243
Modify Code ID .....	243
Custom Suffix .....	254
Enable/Disable Custom Suffix .....	254
Set Custom Suffix .....	254
Data Packing .....	255
Introduction .....	255
Data Packing Options .....	255
Terminating Character Suffix .....	257
Enable/Disable Terminating Character Suffix .....	257
Set Terminating Character Suffix .....	257

<b>Chapter 9 Batch Programming</b> .....	<b>259</b>
Introduction .....	259
Create a Batch Command.....	260
Create a Batch Barcode.....	260
Use Batch Barcode .....	261
<b>Appendix</b> .....	<b>262</b>
Digit Barcodes.....	262
Save/Cancel Barcodes.....	265
Factory Defaults Table .....	266
AIM ID Table.....	275
Code ID Table .....	277
Symbology ID Number .....	279
ASCII Table .....	281
Unicode Key Maps .....	285



# Preface

## Introduction

This manual provides detailed instructions for setting up and using the NLS-FM430 fixed mount barcode scanner (hereinafter referred to as “**the FM430**” or “**the scanner**”).

## Chapter Description

- ✧ *Chapter 1, Getting Started* : Gives a general description of the FM430.
- ✧ *Chapter 2, EasySet* : Introduces a useful tool you can use to set up the FM430.
- ✧ *Chapter 3, System Settings* : Introduces three configuration methods and describes how to configure general parameters of the FM430.
- ✧ *Chapter 4, RS-232 Interface* : Describes how to configure RS-232 communication parameters.
- ✧ *Chapter 5, USB Interface* : Describes how to configure USB communication parameters.
- ✧ *Chapter 6, Symbologies* : Lists all compatible symbologies and describes how to configure the relevant parameters.
- ✧ *Chapter 7, Data Formatter* : Explains how to customize scanned data with the advanced data formatter.
- ✧ *Chapter 8, Prefix & Suffix* : Describes how to use prefix and suffix to customize scanned data.
- ✧ *Chapter 9, Batch Programming* : Explains how to integrate a complex programming task into a single barcode.
- ✧ *Appendix* : Provides factory defaults table and a bunch of frequently used programming barcodes.

---

## Explanation of Icons



This icon indicates something relevant to this manual.



This icon indicates this information requires extra attention from the reader.



This icon indicates handy tips that can help you use or configure the scanner with ease.



This icon indicates practical examples that can help you to acquaint yourself with operations.

# Chapter 1 Getting Started

## Introduction

The FM430 fixed mount barcode scanner, armed with the world-leading Newland patented **UIMG**<sup>®</sup>, a computerized image recognition system-on-chip, bring about a new era of 2D barcode scanner.

The FM430 supports all mainstream 1D and standard 2D barcode symbologies (e.g., PDF417, QR Code, Data Matrix, Aztec and Chinese Sensible Code). It can read barcodes on virtually any medium - paper, plastic card, mobile phones and LCD displays.

Designed for fixed mount integrations, this scanner is easy to fit into various equipment such as self-service cabinets, vending machines, ticket validators, ATMs, access control, retail POS and kiosks.

## Features of the FM430

- Unmatched reading performance: Armed with Newland's fifth-generation of **UIMG**<sup>®</sup> technology, the FM430 is capable of reading 1D as well as high-volume 2D barcodes on the screen covered with protective film.
- IR/Light triggers: The combination of IR sensor and light sensor exhibits an improved sensitivity in activating the scanner to scan barcodes as they are presented, to achieve higher throughput and productivity.
- Highly visible laser aimer: The FM430 provides a laser-generated crosshair aiming pattern that is clear and bright even in bright sunlight, ensuring first time accurate aim.
- Easy to configure and update.

## Unpacking

Open the package and take out the scanner and its accessories. Check to make sure everything on the packing list is present and intact. If any contents are damaged or missing, please keep the original package and contact your dealer immediately for after-sales service.

---

## FM430 Scanner

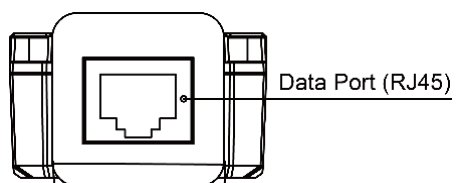
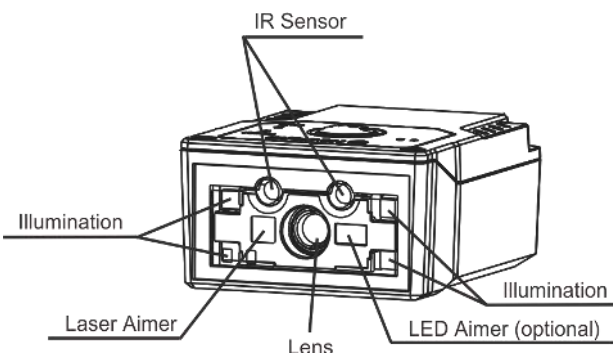
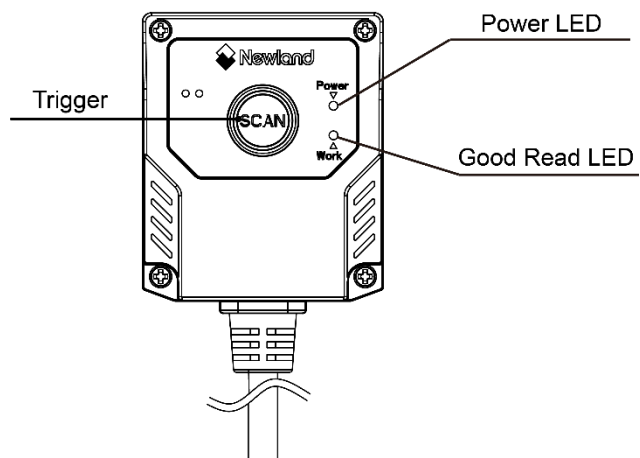
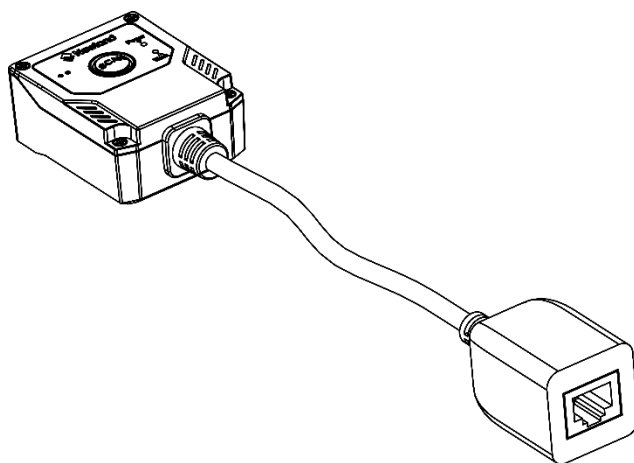

## Data Port Pinout

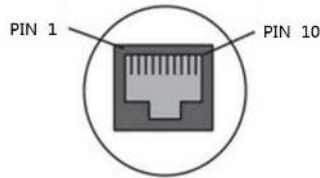

PIN	Signal	Type	Function
1	AGND	P	Ground
2	nTrig	I	Trigger signal input: active low
3	VCC	P	Power+ (DC5V)
4	TXD	O	RS-232 output
5	RXD	I	RS-232 input
6	CTS	I	Clear to send (RS-232)
7	RTS	O	Request to send (RS-232)
8	GND	P	Ground
9	D-	I/O	USB signal
10	D+	I/O	

Driving the nTrig pin (PIN 2) on the data port low for over 10ms causes the scanner to start a scan and decode session. If barcode is decoded, the scanner waits for the voltage at the nTrig pin to turn high (or the trigger to be released) after sending the data to the Host. If the trigger is released during a scan attempt, the scanner immediately stops decoding.

Next decode session does not happen until the scanner receives active trigger signal (driving the nTrig pin low) again.

As a decode session involves image capture, barcode decoding and other steps, it is suggested that the minimum interval between triggers should exceed 50ms.

The following trigger circuit is provided for reference.

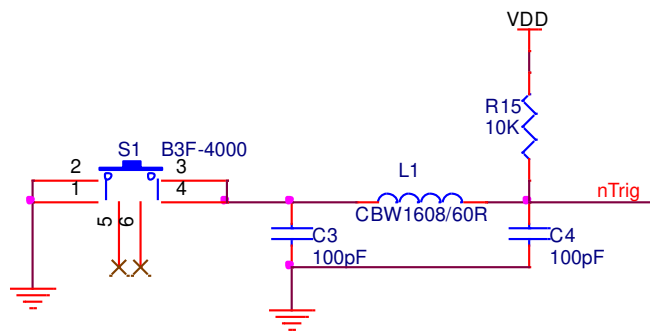

Dimensions (unit: mm)

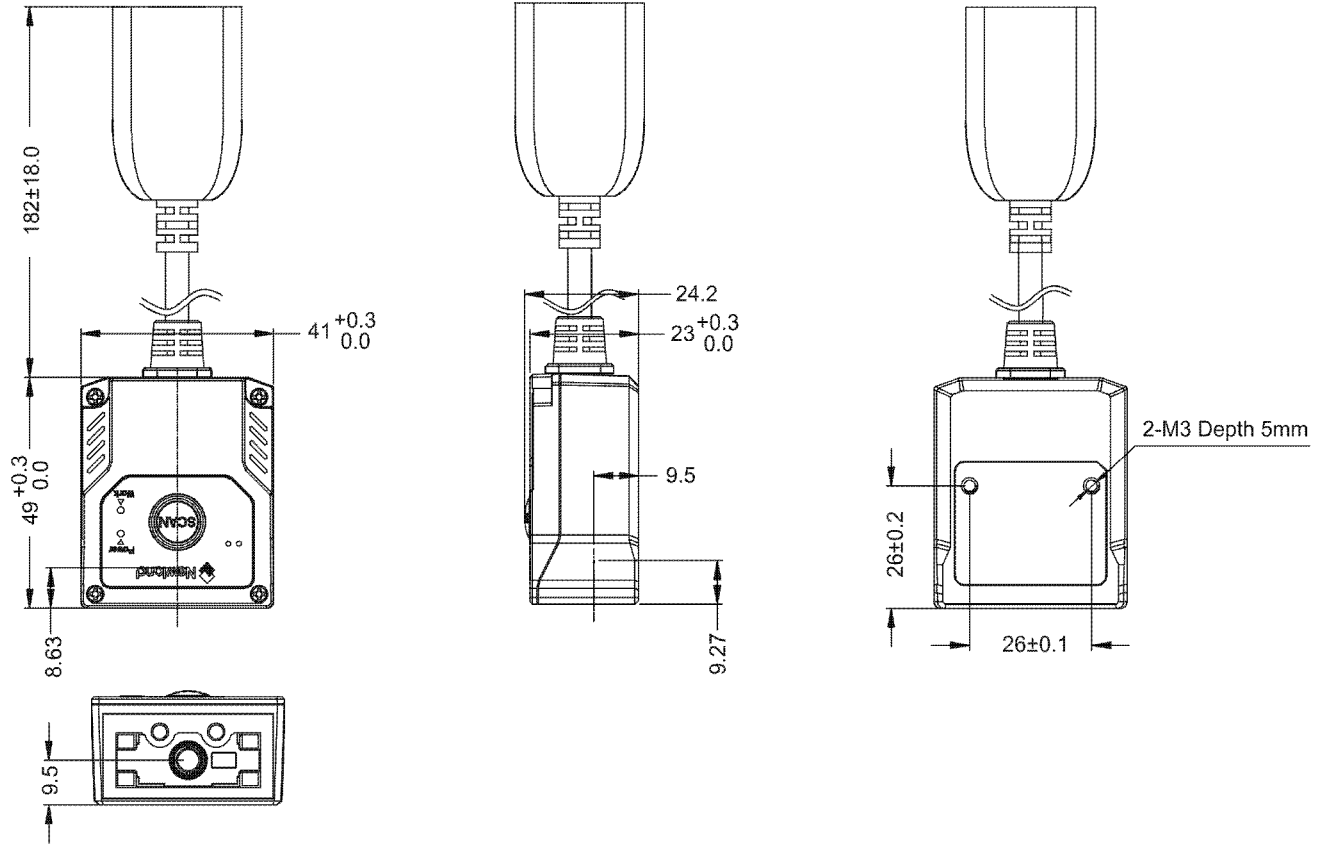

---

## IR Triggering Range

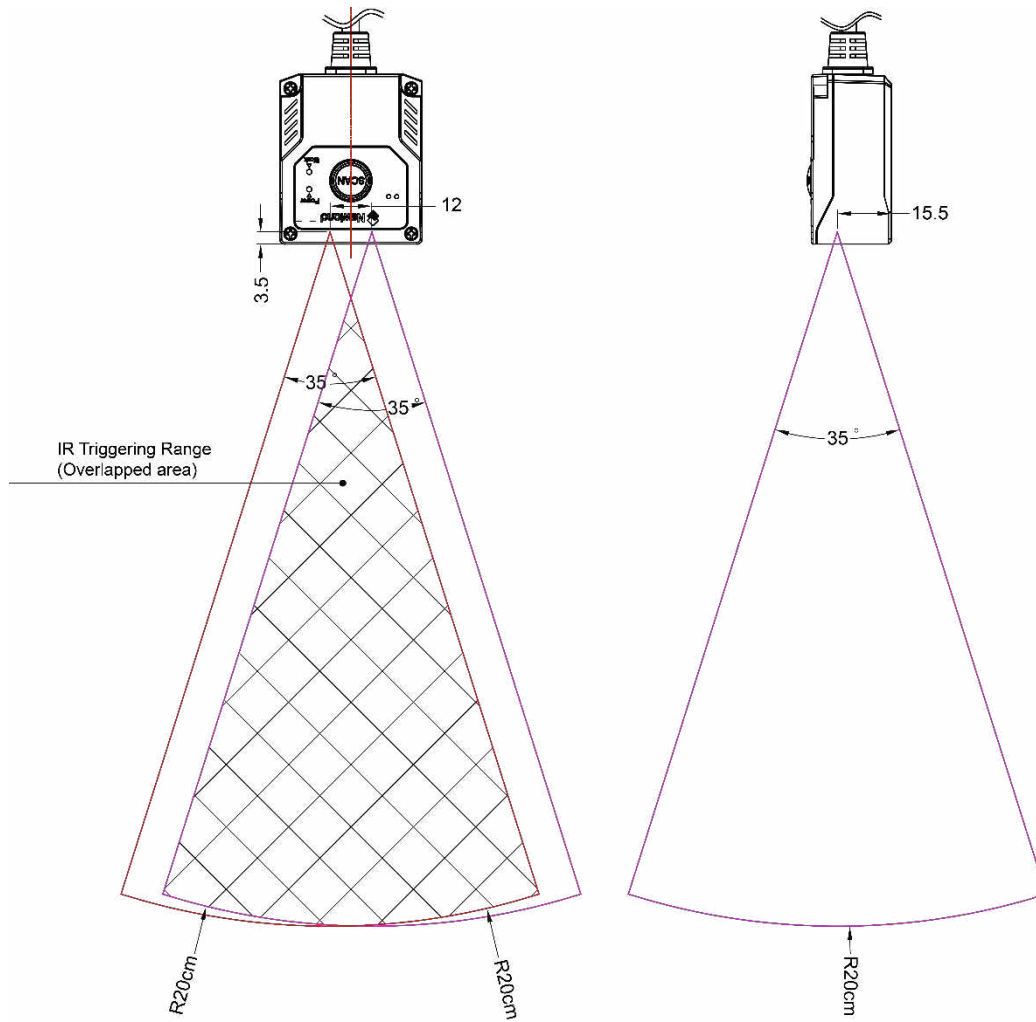

Note: If the IR sensors on the scanner are blocked or covered, the Sense scan mode may not work properly.

---

# Optics

Horizontal FOV:

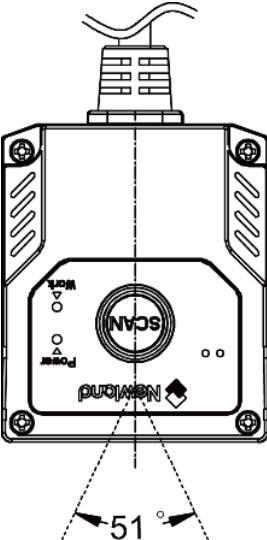

Vertical FOV:

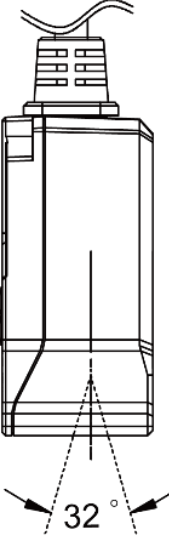



---

## Connecting the FM430 to a Host Device

The scanner must be connected to a host device in actual application, such as PC, POS or any intelligent terminal with USB or RS-232 port, using a USB or RS-232 cable.

### USB

USB port on the host device

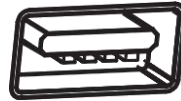

### RS-232

RS-232 port on the host device



**Note:** Please check the port on the host device and purchase the cable accordingly.

---

## Using USB Cable

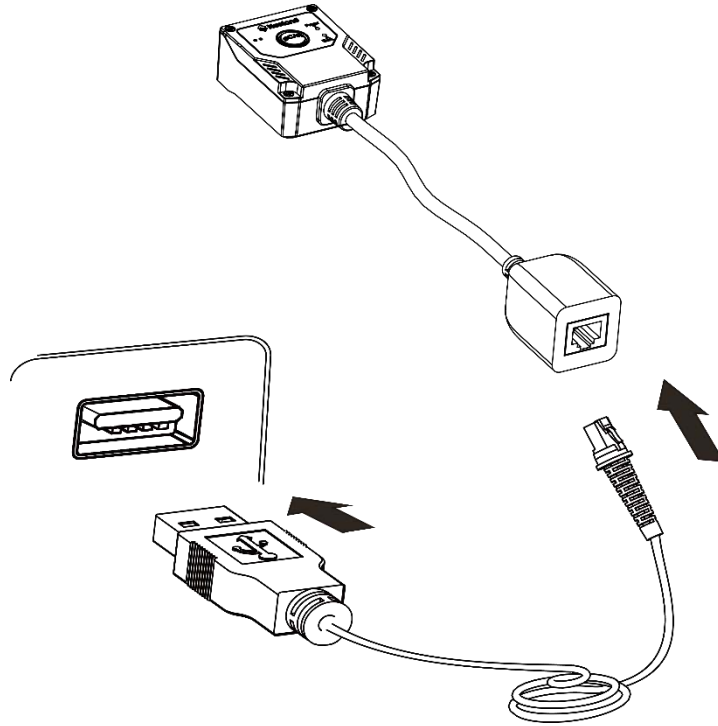

Connect the scanner to a host device with a USB cable with RJ45 and USB connectors:

1. Plug the cable's RJ45 connector into the data port on the scanner.
2. Plug the cable's USB connector into the USB port on the host device.

---

## Using RS-232 Cable

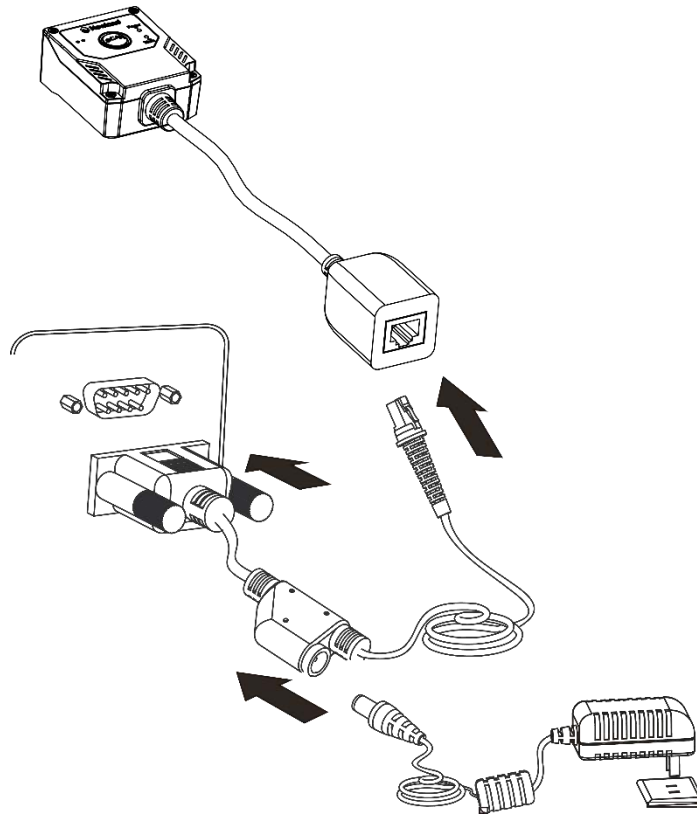

Connect the scanner to a host device with an RS-232 cable with RJ45, RS-232 connector and a power jack:

1. Plug the cable's RJ45 connector into the data port on the scanner.
2. Plug the cable's RS-232 connector into the RS-232 port on the host device.
3. Plug the power adapter into the power jack of the cable.
4. Connect the power adapter to a power outlet.

---

## Scanning Instructions

When the scanner is in the Sense scan mode, you can follow the steps below to scan a barcode:

1. Position the barcode on mobile phone screen or paper in the center of the scan window.
2. For a successful read, the scanner will send the data to the host with its green Good Read LED flashing once.

## Maintenance

- ✧ The scan window should be kept clean.
- ✧ Do not scratch the scan window.
- ✧ Use soft brush to remove the stain from the scan window.
- ✧ Use the soft cloth to clean the window, such as eyeglass cleaning cloth.
- ✧ Do not spray any liquid on the scan window.
- ✧ Do not use any detergent to clean other parts of the device except for water.

**Note: The warranty DOES NOT cover damages caused by inappropriate care and maintenance.**

## Chapter 2 EasySet

EasySet, developed by Fujian Newland Auto-ID Tech. Co., Ltd., is a configuration tool for Newland's 1D/2D handheld barcode scanner, fixed mount barcode scanners and OEM scan engines. Its main features include:

- ✧ View device & configuration information of online device
- ✧ Configure device
- ✧ Update firmware of online device
- ✧ Load/modify existing XML configuration file; save current settings to an XML file
- ✧ Create/print/save programming barcodes to a PDF or Word file
- ✧ View/edit/save image stored on online device in the original image/BMP/JPG/TIFF format
- ✧ Send serial commands to online device and receive device response
- ✧ Supported languages: Chinese and English.

EasySet supports 32-bit/64-bit Microsoft WinXP/Win7/Win 8/Win 8.1/Win 10 operating systems.

EasySet can communicate with device via one of the following interface: RS-232, USB COM Port Emulation (UFCOM driver required), USB CDC (UFCOM driver required), USB DataPipe (UFCOM driver required), USB HID-POS.

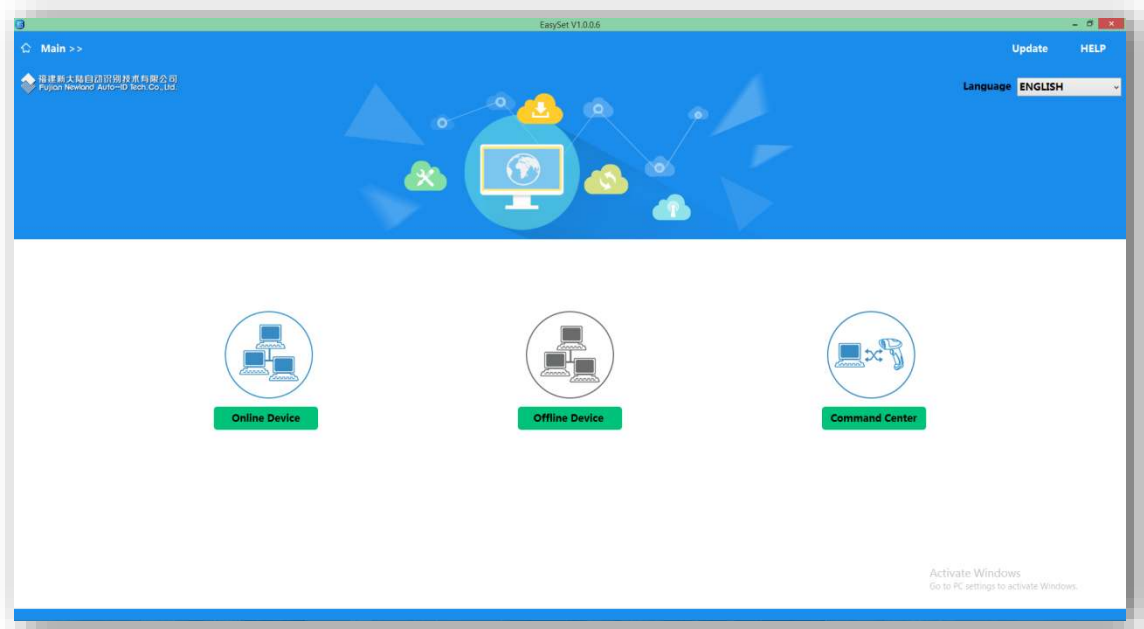



@SETUPE1  
Enter Setup

## Chapter 3 System Settings

### Introduction

There are three ways to configure the FM430: Barcode programming, command programming and Easysset programming.

#### Barcode Programming

The FM430 can be configured by scanning programming barcodes. All user programmable features/options are described along with their programming barcodes/commands in the following sections.

This programming method is most straightforward. However, it requires manually scanning barcodes. As a result, errors are more likely to occur.

#### Command Programming

The FM430 can also be configured by serial commands sent from the host device.

Users can design an application program to send those command strings to the scanners to perform device configuration.

For more information, refer to the *Programming Guide Based on Newland Unified Commands Set*.

#### EasySet Programming

Besides the two methods mentioned above, you can conveniently perform scanner configuration through EasySet too. EasySet is a Windows-based configuration tool particularly designed for Newland products, enabling users to gain access to decoded data and captured images and to configure scanners. For more information about this tool, refer to the *EasySet User Guide*.



@SETUPE0  
\*\* Exit Setup



@SETUPE1  
Enter Setup

## Programming Barcode/ Programming Command/Function



The figure above is an example that shows you the programming barcode and command for the Enter Setup function:

1. The **No Case Conversion** barcode.
2. The **No Case Conversion** command.
3. The description of feature/option.
4. \*\* indicates factory default settings.

Note: "@" included in the programming command indicates permanent setting which means the setting will not be lost by removing power from the scanner or turning off or rebooting it; whereas "#" included in the programming command indicates temporary setting which means the setting will be lost by removing power from the scanner or turning off or rebooting it.



@SETUPE0  
\*\* Exit Setup



@SETUPE1  
Enter Setup

---

## Use of Programming Command

Besides the barcode programming method, the scanner can also be configured by serial commands (HEX) sent from the host device. **All commands must be entered in uppercase letters.**

### Command Syntax

*Prefix StorageType Tag SubTag {Data} [,SubTag {Data}] [:Tag SubTag {Data}] [...] Suffix*

**Prefix:** "~<SOH>0000" (HEX: **7E 01 30 30 30 30**), 6 characters.

**StorageType:** "@" (HEX: **40**) or "#" (HEX: **23**), 1 character. "@" means permanent setting which will not be lost by removing power from the scanner or rebooting it; "#" means temporary setting which will be lost by removing power from the scanner or rebooting it.

**Tag:** A 3-character case-sensitive field that identifies the desired command group. For example, all USB HID Keyboard configuration settings are identified with a Tag of KBW.

**SubTag:** A 3-character case-sensitive field that identifies the desired parameter within the tag group. For example, the SubTag for the keyboard layout is CTY.

**Data:** The value for a feature or parameter setting, identified by the Tag and SubTag.

**Suffix:** ";<ETX>" (HEX: **3B 03**), 2 characters.

Multiple commands can be issued within one Prefix/Suffix sequence. For configuration commands, only the **Tag**, **SubTag**, and **Data** fields must be repeated for each command in sequence. If an additional command is to be applied to the same Tag, then the command is separated with a comma (,) and only the **SubTag** and **Data** fields of the additional commands are issued. If the additional command requires a different **Tag** field, the command is separated from previous command by a semicolon (;).

### Query Commands

For query commands, the entry in the **Data** field in the syntax above is one of the following characters means:

- \* (HEX: **2A**)      What is the scanner's current value for the setting(s).
- & (HEX: **26**)      What is the factory default value for the setting(s).
- ^ (HEX: **5E**)      What is the range of possible values for the setting(s).



@SETUPE0  
\*\* Exit Setup





@SETUPE1  
Enter Setup

The value of the **StoreType** field in a query command can be either "@" (HEX: 40) or "#" (HEX: 23).

A query command with the **SubTag** field omitted means to query all the settings concerning a tag. For example, to query all the current settings about Code 11, you should enter **7E 01 30 30 30 30 40 43 31 31 2A 3B 03** (i.e. ~<SOH>0000@C11\*; <ETX>).

## Responses

Different from command sequence, the prefix of a response consists of the six characters of "<STX><SOH>0000" (HEX: **02 01 30 30 30 30**).

The scanner responds to serial commands with one of the following three responses:

- <ACK> (HEX: 06)     Indicates a good command which has been processed.
- <NAK> (HEX: 15)     Indicates a good configuration command with its **Data** field entry out of the allowable range for this Tag and SubTag combination (e.g. an entry for an inter-keystroke delay of 100 when the field will only allow 2 digits), or an invalid query command.
- <ENQ> (HEX: 05)     Indicates an invalid Tag or SubTag command.

When responding, the scanner echoes back the command sequence with the status character above inserted directly before each of the punctuation marks (the comma or semicolon) in the command.

## Examples

### Example 1: Enable Code 11, set the minimum and maximum lengths to 12 and 22 respectively.

Enter:     **7E 01 30 30 30 30 40 43 31 31 45 4E 41 31 2C 4D 49 4E 31 32 2C 4D 41 58 32 32 3B 03**  
(~<SOH>0000@C11ENA1,MIN12,MAX22;<ETX>)

Response: **02 01 30 30 30 30 40 43 31 31 45 4E 41 31 06 2C 4D 49 4E 31 32 06 2C 4D 41 58 32 32 06 3B 03**  
(<STX><SOH>0000@C11ENA1<ACK>,MIN12<ACK>,MAX22<ACK>;<ETX>)

### Example 2: Query the current minimum and maximum lengths of Code 11.

Enter:     **7E 01 30 30 30 30 40 43 31 31 4D 49 4E 2A 2C 4D 41 58 2A 3B 03**  
(~<SOH>0000@C11MIN\*,MAX\*;<ETX>)

Response: **02 01 30 30 30 30 40 43 31 31 4D 49 4E 31 32 06 2C 4D 41 58 32 32 06 3B 03**  
(<STX><SOH>0000@C11MIN12<ACK>,MAX22<ACK>;<ETX>)



@SETUPE0  
\*\* Exit Setup



@SETUPE1  
Enter Setup

---

## Use of Programming Barcodes

Scanning the **Enter Setup** barcode can enable the scanner to enter the setup mode. Then you can scan a number of programming barcodes to configure your scanner. To exit the setup mode, scan the **Exit Setup** barcode or a non-programming barcode, or reboot the scanner.



@SETUPE0  
**\*\* Exit Setup**

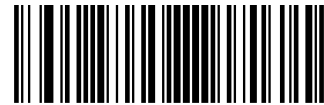

@SETUPE1  
**Enter Setup**

Programming barcode data (i.e. the characters under programming barcode) can be transmitted to the host device. Scan the appropriate barcode below to enable or disable the transmission of programming barcode data to the host device.



@SETUPT0  
**\*\* Do Not Transmit Programming Barcode Data**



@SETUPT1  
**Transmit Programming Barcode Data**



@SETUPE0  
**\*\* Exit Setup**



@SETUPE1  
Enter Setup

---

## Illumination

A couple of illumination options are provided to improve the lighting conditions during every image capture:

**Normal:** Illumination LEDs are turned on during image capture.

**Always On:** Illumination LEDs keep on after the scanner is powered on.

**Off:** Illumination LEDs are off all the time.

**Fade Up:** Illumination LEDs are dimly lit when in standby mode and gradually increase their brightness during image capture.



@ILLSCN1  
**\*\* Normal**



@ILLSCN0  
**Off**



@ILLSCN2  
**Always On**



@ILLSCN3  
**Fade Up**



@SETUPE0  
**\*\* Exit Setup**



@SETUPE1  
Enter Setup

---

## Aiming

When scanning/capturing image, the scanner projects an aiming pattern which allows positioning the target barcode within its field of view and thus makes decoding easier.

**Normal:** The scanner projects an aiming pattern only during barcode scanning/capture.

**Always On:** Aiming pattern is constantly on after the scanner is powered on.

**Off:** Aiming pattern is off all the time.



@AMLENA1  
**\*\* Normal**



@AMLENA0  
**Off**



@AMLENA2  
**Always On**

## Good Read LED

The green LED can be programmed to be On or Off to indicate good read.



@GRLENA1  
**\*\* On**



@GRLENA0  
**Off**



@SETUPE0  
**\*\* Exit Setup**



@SETUPE1  
**Enter Setup**

### Good Read LED Duration

This parameter sets the amount of time that the Good Read LED to remain on following a good read. It is programmable in 1ms increments from 1ms to 2,500ms.



@GRLDUR20  
**\*\* Short (20ms)**



@GRLDUR120  
**Medium (120ms)**



@GRLDUR220  
**Long (220ms)**



@GRLDUR320  
**Prolonged (320ms)**



@GRLDUR  
**Custom (1 - 2,500ms)**

**E**  
*example*

#### Set the Good Read LED duration to 800ms:

1. Scan the **Enter Setup** barcode.
2. Scan the **Custom** barcode.
3. Scan the numeric barcodes "8", "0" and "0" from the "Digit Barcodes" section in Appendix.
4. Scan the **Save** barcode from the "Save/Cancel Barcodes" section in Appendix.
5. Scan the **Exit Setup** barcode.



@SETUPE0  
**\*\* Exit Setup**



@SETUPE1  
Enter Setup

---

## Power On Beep

The scanner can be programmed to beep when it is powered on. Scan the **Off** barcode if you do not want a power on beep.



@PWBENA1  
\*\* On



@PWBENA0  
Off

## Good Read Beep

Scanning the **Off** barcode can turn off the beep that indicates successful decode; scanning the **On** barcode can turn it back on.



@GRBENA1  
\*\* On



@GRBENA0  
Off



@SETUPE0  
\*\* Exit Setup



@SETUPE1  
**Enter Setup**

## Good Read Beep Duration

This parameter sets the length of the beep the scanner emits on a good read. It is programmable in 1ms increments from 20ms to 300ms.



@GRBDUR40  
**Short (40ms)**



@GRBDUR80  
**\*\* Medium (80ms)**



@GRBDUR120  
**Long (120ms)**



@GRBDUR  
**Custom (20 – 300ms)**

**E**  
*xample*

**Set the Good Read Beep duration to 200ms:**

1. Scan the **Enter Setup** barcode.
2. Scan the **Custom** barcode.
3. Scan the numeric barcodes “2”, “0” and “0” from the “Digit Barcodes” section in Appendix.
4. Scan the **Save** barcode from the “Save/Cancel Barcodes” section in Appendix.
5. Scan the **Exit Setup** barcode.



@SETUPE0  
**\*\* Exit Setup**



@SETUPE1  
Enter Setup

---

## Good Read Beep Frequency

This parameter is programmable in 1Hz increments from 20Hz to 20,000Hz.



@GRBFRQ800  
Extra Low (800Hz)



@GRBFRQ1600  
Low (1600Hz)



@GRBFRQ2730  
\*\* Medium (2730Hz)



@GRBFRQ4200  
High (4200Hz)



@GRBFRQ  
Custom (20 - 20,000Hz)

**E**  
*example*

### Set the Good Read Beep frequency to 2,000Hz:

1. Scan the **Enter Setup** barcode.
2. Scan the **Custom** barcode.
3. Scan the numeric barcodes “2”, “0”, “0” and “0” from the “Digit Barcodes” section in Appendix.
4. Scan the **Save** barcode from the “Save/Cancel Barcodes” section in Appendix.
5. Scan the **Exit Setup** barcode.



@SETUPE0  
\*\* Exit Setup





@SETUPE1  
**Enter Setup**

---

## Good Read Beep Volume

There are 20 volume levels to choose from. The bigger the value, the louder the Good Read Beep.



@GRBVLL20  
**\*\* Loud**



@GRBVLL8  
**Medium**



@GRBVLL2  
**Low**



@GRBVLL  
**Custom Volume (Level 1-20)**

## **E** *example*

### Set the Good Read Beep volume to Level 8:

1. Scan the **Enter Setup** barcode.
2. Scan the **Custom Volume** barcode.
3. Scan the numeric barcode “8” from the “Digit Barcodes” section in Appendix.
4. Scan the **Save** barcode from the “Save/Cancel Barcodes” section in Appendix.
5. Scan the **Exit Setup** barcode.

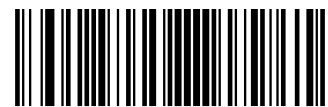

@SETUPE0  
**\*\* Exit Setup**



@SETUPE1  
Enter Setup

---

## Scan Mode

- ✧ **Level Mode:** A trigger pull activates a decode session. The decode session continues until a barcode is decoded or you release the trigger.
- ✧ **Sense Mode:** The scanner activates a decode session every time it detects a barcode presented to it. The decode session continues until a barcode is decoded or the decode session timeout expires. **Reread Timeout** can avoid undesired rereading of same barcode in a given period of time. **Image Stabilization Timeout** gives the scanner time to adapt to ambient environment after it decodes a barcode and “looks” for another. **Image Change Trigger Sensitivity** can change the Sense Mode’s sensibility to changes in images captured, while **IR Proximity Trigger Sensitivity** can adjust the Sense Mode’s sensibility in detecting barcodes presented to the scanner.
- ✧ **Continuous Mode:** The scanner automatically starts one decode session after another. To suspend/resume barcode reading, simply press the trigger. **Timeout between Decodes (Same Barcode)** can avoid undesired rereading of same barcode in a given period of time. Note that when switching to this mode by scanning the **Continuous Mode** barcode, the scanner will stop barcode reading for 3 seconds before starting scanning continuously.
- ✧ **Pulse Mode:** When the trigger is pulled and released, scanning is activated until a barcode is decoded or the decode session timeout expires (The decode session timeout begins when the trigger is released).



@SCNMOD0  
**Level Mode**



@SCNMOD2  
**\*\* Sense Mode**



@SCNMOD3  
**Continuous Mode**



@SCNMOD4  
**Pulse Mode**



@SETUPE0  
**\*\* Exit Setup**



@SETUPE1  
**Enter Setup**

---

## Decode Session Timeout

This parameter sets the maximum time decode session continues during a scan attempt. It is programmable in 1ms increments from 1ms to 3,600,000ms. When it is set to 0, the timeout is infinite. The default setting is 3,000ms.



@ORTSET  
**Decode Session Timeout**

**E**  
*sample*

**Set the decode session timeout to 1,500ms:**

1. Scan the **Enter Setup** barcode.
2. Scan the **Decode Session Timeout** barcode.
3. Scan the numeric barcodes “1”, “5”, “0” and “0” from the “Digit Barcodes” section in Appendix.
4. Scan the **Save** barcode from the “Save/Cancel Barcodes” section in Appendix.
5. Scan the **Exit Setup** barcode.

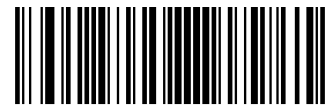

@SETUPE0  
**\*\* Exit Setup**



@SETUPE1  
Enter Setup

---

## Image Stabilization Timeout (Sense Mode)

This parameter defines the amount of time the scanner will spend adapting to ambient environment after it decodes a barcode and “looks” for another. It is programmable in 1ms increments from 0ms to 3,000ms. The default setting is 200ms.



@SENIST  
Image Stabilization Timeout

**E**  
*sample*

**Set the image stabilization timeout to 800ms:**

1. Scan the **Enter Setup** barcode.
2. Scan the **Image Stabilization Timeout** barcode.
3. Scan the numeric barcodes “8”, “0” and “0” from the “Digit Barcodes” section in Appendix.
4. Scan the **Save** barcode from the “Save/Cancel Barcodes” section in Appendix.
5. Scan the **Exit Setup** barcode.



@SETUPE0  
\*\* Exit Setup



@SETUPE1  
Enter Setup

## Reread Timeout

Reread Timeout can avoid undesired rereading of same barcode in a given period of time. This feature is only applicable to the Sense and Continuous modes.

To enable/disable the Reread Timeout, scan the appropriate barcode below.

**Enable Reread Timeout:** Do not allow the scanner to re-read same barcode before the reread timeout expires.

**Disable Reread Timeout:** Allow the scanner to re-read same barcode.



@RRDENA1  
Enable Reread Timeout



@RRDENA0  
\*\* Disable Reread Timeout

The following parameter sets the time interval between two successive reads on same barcode. It is programmable in 1ms increments from 0ms to 3,600,000ms. When it is set to a value greater than 3,000, the timeout for rereading same programming barcode is limited to 3,000ms. The default setting is 1,500ms.



@RRDDUR  
Reread Timeout

**E**  
*example*

### Set the reread timeout to 1,000ms:

1. Scan the **Enter Setup** barcode.
2. Scan the **Reread Timeout** barcode.
3. Scan the numeric barcodes "1", "0", "0" and "0" from the "Digit Barcodes" section in Appendix.
4. Scan the **Save** barcode from the "Save/Cancel Barcodes" section in Appendix.
5. Scan the **Exit Setup** barcode.



@SETUPE0  
\*\* Exit Setup



@SETUPE1  
**Enter Setup**

---

You may wish to restart the reread timeout when the scanner encounters the same barcode that was decoded in the last scan session before the reread timeout expires. To enable this feature, scan the **Reread Timeout Reset On** barcode. This feature is only effective when **Reread Timeout** is enabled.



@RRDREN1  
**Reread Timeout Reset On**



\*\* **Reread Timeout Reset Off**

## Image Decoding Timeout

Image Decoding Timeout specifies the maximum time the scanner will spend decoding an image. This parameter is programmable in 1 ms increments from 1ms to 3,000ms. The default timeout is 500ms.



@DETSET  
**Image Decoding Timeout**

**E**  
*example*

**Set the image decoding timeout to 1,000ms:**

1. Scan the **Enter Setup** barcode.
2. Scan the **Image Decoding Timeout** barcode.
3. Scan the numeric barcodes “1”, “0”, “0” and “0” from the “Digit Barcodes” section in Appendix.
4. Scan the **Save** barcode from the “Save/Cancel Barcodes” section in Appendix.
5. Scan the **Exit Setup** barcode.



@SETUPE0  
**\*\* Exit Setup**



@SETUPE1  
**Enter Setup**

## Good Read Delay

Good Read Delay sets the minimum amount of time before the scanner can read another barcode after a good read. This parameter is programmable in 1ms increments from 1ms to 3,600,000ms. The default setting is 500ms. Scan the appropriate barcode below to enable or disable the delay.



@GRDENA1  
**Enable Good Read Delay**



@GRDENA0  
**\*\* Disable Good Read Delay**

To set the good read delay, scan the barcode below, then set the delay (from 1 to 3,600,000ms) by scanning the digit barcode(s) then scanning the **Save** barcode from the Appendix.



@GRDDUR  
**Good Read Delay**

**E**  
*sample*

### Set the good read delay to 1,000ms:

1. Scan the **Enter Setup** barcode.
2. Scan the **Good Read Delay** barcode.
3. Scan the numeric barcodes "1", "0", "0" and "0" from the "Digit Barcodes" section in Appendix.
4. Scan the **Save** barcode from the "Save/Cancel Barcodes" section in Appendix.
5. Scan the **Exit Setup** barcode.



@SETUPE0  
**\*\* Exit Setup**



@SETUPE1  
Enter Setup

---

## Trigger Selection (Sense Mode)



@SENTRG0  
Image Change Trigger



@SENTRG1  
IR Proximity Trigger

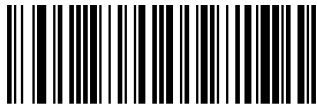

@SENTRG2  
\*\* Both



@SETUPE0  
\*\* Exit Setup





@SETUPE1  
**Enter Setup**

## Image Change Trigger Sensitivity

This specifies the degree of acuteness of the scanner's response to changes in images captured. There are 20 levels to choose from. The smaller the value, the higher the sensitivity and the lower requirement in image change to trigger the scanner. You can select an appropriate degree of sensitivity that fits your application environment. This feature is only applicable to the Sense mode.



@SENLVL14  
**Low Sensitivity**



@SENLVL11  
**\*\* Medium Sensitivity**



@SENLVL8  
**High Sensitivity**



@SENLVL5  
**Enhanced Sensitivity**



@SENLVL  
**Custom Sensitivity (Level 1-20)**

**E**  
*xample*

### Set the image change trigger sensitivity to Level 10:

1. Scan the **Enter Setup** barcode.
2. Scan the **Custom Sensitivity** barcode.
3. Scan the numeric barcodes "1" and "0" from the "Digit Barcodes" section in Appendix.
4. Scan the **Save** barcode from the "Save/Cancel Barcodes" section in Appendix.
5. Scan the **Exit Setup** barcode.



@SETUPE0  
**\*\* Exit Setup**



@SETUPE1  
**Enter Setup**

---

## IR Proximity Trigger Sensitivity

This specifies the degree of acuteness of the scanner's "sense" to detect barcodes presented to it. There are 10 levels to choose from. The smaller the value, the higher the sensitivity and the further the scanner can reach. You can select an appropriate degree of sensitivity that fits your application needs. This feature is only applicable to the Sense mode.



@SENIRL9  
**Low Sensitivity**



@SENIRL3  
**\*\* High Sensitivity**



@SENIRL6  
**Medium Sensitivity**



@SENIRL  
**Custom Sensitivity (Level 1-10)**

**E**  
*xample*

### Set the IR proximity trigger sensitivity to Level 10:

1. Scan the **Enter Setup** barcode.
2. Scan the **Custom Sensitivity** barcode.
3. Scan the numeric barcodes "1" and "0" from the "Digit Barcodes" section in Appendix.
4. Scan the **Save** barcode from the "Save/Cancel Barcodes" section in Appendix.
5. Scan the **Exit Setup** barcode.



@SETUPE0  
**\*\* Exit Setup**



@SETUPE1  
Enter Setup

## Trigger Commands

When **Enable Trigger Commands** is selected, you can activate and deactivate the scanner in the Level mode with serial trigger commands. Sending the **Start Scanning** command (default: <SOH> T <EOT>, user-programmable) to the scanner in the Level mode activates a decode session. The decode session continues until a barcode is decoded or the decode session timeout expires or the scanner receives the **Stop Scanning** command (default: <SOH> P <EOT>, user-programmable).



@SCNTCE0  
**\*\* Disable Trigger Commands**



@SCNTCE1  
**Enable Trigger Commands**

## Modify Start Scanning Command

The **Start Scanning** command can consist of 1-10 characters (HEX values from 0x01 to 0xFF). In this command, the character “?” (HEX: 0x3F) cannot be the first character. The default **Start Scanning** command is <SOH> T <EOT>.



@SCNTCT  
**Modify Start Scanning Command**

**E**  
*xample*

**Set the Start Scanning command to “\*T”:**

1. Scan the **Enter Setup** barcode.
2. Scan the **Modify Start Scanning Command** barcode.
3. Scan the numeric barcodes “2”, “A”, “5” and “4” from the “Digit Barcodes” section in Appendix.
4. Scan the **Save** barcode from the “Save/Cancel Barcodes” section in Appendix.
5. Scan the **Exit Setup** barcode.



@SETUPE0  
**\*\* Exit Setup**



@SETUPE1  
Enter Setup

---

## Modify Stop Scanning Command

The **Stop Scanning** command can consist of 1-10 characters (HEX values from 0x01 to 0xFF). In this command, the character “?” (HEX: 0x3F) cannot be the first character. The default **Stop Scanning** command is <SOH> P <EOT>.



@SCNTCP  
**Modify Stop Scanning Command**

**E**  
*sample*

**Set the Stop Scanning command to “\*P”:**

1. Scan the **Enter Setup** barcode.
2. Scan the **Modify Stop Scanning Command** barcode.
3. Scan the numeric barcodes “2”, “A”, “5” and “0” from the “Digit Barcodes” section in Appendix.
4. Scan the **Save** barcode from the “Save/Cancel Barcodes” section in Appendix.
5. Scan the **Exit Setup** barcode.



@SETUPE0  
**\*\* Exit Setup**



@SETUPE1  
Enter Setup

---

## Scanning Preference

**Normal Mode:** Select this mode when reading barcodes on paper.

**Screen Mode:** Select this mode when reading barcodes on the screen.

**Barcode Pay Mode:** Select this mode when reading barcodes to perform payment transactions, such as Alipay, WeChat Pay barcodes.



@EXPLVL0  
**\*\* Normal Mode**



@EXPLVL2  
**Screen Mode**



@EXPLVL5  
**Barcode Pay Mode**



@SETUPE0  
**\*\* Exit Setup**



@SETUPE1  
Enter Setup

---

## Read Barcode On/Off

Sending the Read Barcode Off command `~<SOH>0000#SCNENA0;<ETX>` to the scanner can disable it from reading barcode, and the scanner is unable to scan barcode unless you send the Read Barcode On command `~<SOH>0000#SCNENA1;<ETX>` to it or power cycle it. By default, Read Barcode is On.

## Make a Beeping Sound

You may wish to force the scanner to beep upon a command sent from the host. A beeping sound is made to gain a user's attention to an error or other important event.

BEEPONxxxFyyyT (xxx: The desired frequency, 1-20,000Hz; yyy: The desired duration, 1-10,000ms)

### Example: Make a 50ms beep at 2,000Hz

Enter: **7E 01 30 30 30 30 40 42 45 45 50 4F 4E 32 30 30 30 46 35 30 54 3B 03**  
(`~<SOH>0000#BEEPON2000F50T;<ETX>`)

Response: **02 01 30 30 30 30 40 42 45 45 50 4F 4E 32 30 30 30 46 35 30 54 06 3B 03**  
(`<STX><SOH>0000#BEEPON2000F50T<ACK>;<ETX>`)

## Turn On Good Read LED

You may turn on the Good Read LED on the scanner for a certain period of time with a command sent from the host. When using this feature you should first query the range of possible values for the setting. Note that the scanner **cannot** scan barcodes when it is executing this command.

LEDONSxCyyD (x: Specify the LED color: 0 – Red, 1 – White, 2 – Green, 3 - Blue; yy: Specify the length of time the LED stays lit, 10-3,600,000ms)

Command for querying whether the scanner supports this feature: LEDONS\* or LEDONS&

Returning LEDONS<ACK> indicates the scanner supports this feature.

Command for querying the range of possible values for the setting: LEDONS^

Returning LEDONS0-3C10-3600000D <ACK> indicates LED color options include red, white, green and blue, and the range for the length of time the LED stays lit is 10-3,600,000ms.

### Example: Turn on the red Good Read LED for 2,000ms

Enter: `~<SOH>0000#LEDONS0C2000D;<ETX>`

Response: `<STX><SOH>0000#LEDONS0C2000D<ACK>;<ETX>`



@SETUPE0  
\*\* Exit Setup



@SETUPE1  
Enter Setup

---

## Turn On Illumination LED

You may turn on the illumination LED on the scanner for a certain period of time with a command sent from the host. When using this feature you should first query the range of possible values for the setting. Note that the scanner **cannot** scan barcodes when it is executing this command.

LEDONIxCyyD (x: Specify the LED color: 0 – Red, 1 – White, 2 – Green, 3 - Blue; yy: Specify the length of time the LED stays lit, 10-3,600,000ms)

Command for querying whether the scanner supports this feature: LEDONI\* or LEDONI&  
Returning LEDONI<ACK> indicates the scanner supports this feature.

Command for querying the range of possible values for the setting: LEDONI^  
Returning LEDONI0-3C10-3600000D <ACK> indicates LED color options include red, white, green and blue, and the range for the length of time the LED stays lit is 10-3,600,000ms.

### Example: Turn on the white illumination LED for 2,000ms

Enter: ~<SOH>0000#LEDONI1C2000D;<ETX>  
Response: <STX><SOH>0000#LEDONI1C2000D<ACK>;<ETX>

## Turn On Aimer

You may turn on the aimer on the scanner for a certain period of time with a command sent from the host. When using this feature you should first query the range of possible values for the setting. Note that the scanner **cannot** scan barcodes when it is executing this command.

LEDONAYy (yy: Specify the length of time the aimer stays on, 10-3,600,000ms)

Command for querying whether the scanner supports this feature: LEDONA\* or LEDONA&  
Returning LEDONA<ACK> indicates the scanner supports this feature.

Command for querying the range of possible values for the setting: LEDONA^  
Returning LEDONA10-3600000 <ACK> indicates the range for the length of time the aimer stays on is 10-3,600,000ms.

### Example: Turn on the aimer for 2,000ms

Enter: ~<SOH>0000#LEDONA2000;<ETX>  
Response: <STX><SOH>0000#LEDONA2000<ACK>;<ETX>



@SETUPE0  
\*\* Exit Setup



@SETUPE1  
Enter Setup

## Decode Area

**Whole Area Decoding:** The scanner attempts to decode barcode(s) within its field of view, from the center to the periphery, and transmits the barcode that has been first decoded.

**Specific Area Decoding:** The scanner attempts to read barcode(s) within a specified decoding area and transmits the barcode that has been first decoded. This option allows the scanner to narrow its field of view to make sure it reads only those barcodes intended by the user. For instance, if multiple barcodes are placed closely together, specific area decoding in conjunction with appropriate pre-defined decoding area will insure that only the desired barcode is read.



\*\* Whole Area Decoding



Specific Area Decoding

If **Specific Area Decoding** is enabled, the scanner only reads barcodes that intersect the predefined decoding area. The default decoding area is an area of 40% top, 60% bottom, 40% left and 60% right of the scanner's field of view

You can define the decoding area using the **Top of Decoding Area**, **Bottom of Decoding Area**, **Left of Decoding Area** and **Right of Decoding Area** barcodes as well as numeric barcode(s) that represent(s) a desired percentage (0-100). The value of Bottom must be greater than that of Top; the value of Right must be greater than that of Left.



Top of Decoding Area



Bottom of Decoding Area



Left of Decoding Area



Right of Decoding Area



@SETUPE0  
\*\* Exit Setup





@SETUPE1  
Enter Setup



## Example

Program the scanner to only read Barcode 1 in the figure above by setting the decoding area to 10% top, 45% bottom, 15% left and 30% right:

1. Scan the **Enter Setup** barcode.
2. Scan the **Top of Decoding Area** barcode.
3. Scan the numeric barcode "0" from the "Digit Barcodes" section in Appendix.
4. Scan the **Save** barcode from the "Save/Cancel Barcodes" section in Appendix.
5. Scan the **Bottom of Decoding Area** barcode.
6. Scan the numeric barcodes "4" and "5" from the "Digit Barcodes" section in Appendix.
7. Scan the **Save** barcode from the "Save/Cancel Barcodes" section in Appendix.
8. Scan the **Top of Decoding Area** barcode.
9. Scan the numeric barcodes "1" and "0" from the "Digit Barcodes" section in Appendix.
10. Scan the **Save** barcode from the "Save/Cancel Barcodes" section in Appendix.
11. Scan the **Left of Decoding Area** barcode.
12. Scan the numeric barcode "0" from the "Digit Barcodes" section in Appendix.
13. Scan the **Save** barcode from the "Save/Cancel Barcodes" section in Appendix.
14. Scan the **Right of Decoding Area** barcode.
15. Scan the numeric barcodes "3" and "0" from the "Digit Barcodes" section in Appendix.
16. Scan the **Save** barcode from the "Save/Cancel Barcodes" section in Appendix.
17. Scan the **Left of Decoding Area** barcode.
18. Scan the numeric barcodes "1" and "5" from the "Digit Barcodes" section in Appendix.
19. Scan the **Save** barcode from the "Save/Cancel Barcodes" section in Appendix.
20. Scan the **Exit Setup** barcode.



@SETUPE0  
\*\* Exit Setup



@SETUPE1  
Enter Setup

---

## Image Flipping



@MIRROR0  
\*\* Do Not Flip



@MIRROR1  
Flip Horizontally



@MIRROR2  
Flip Vertically



@MIRROR3  
Flip Horizontally & Vertically

Example of image not flipped



Example of image flipped horizontally



Example of image flipped vertically



Example of image flipped horizontally & vertically



@SETUPE0  
\*\* Exit Setup



@SETUPE1  
**Enter Setup**

## Bad Read Message

Scan the appropriate barcode below to select whether or not to send a bad read message (user-programmable) when a good read does not occur before trigger release, or the decode session timeout expires, or the scanner receives the **Stop Scanning** command (For more information, see the “Serial Trigger Command” section in this Chapter).



@NGRENA0  
**\*\* Bad Read Message OFF**



@NGRENA1  
**Bad Read Message ON**

## Set Bad Read Message

A bad read message can contain up to 7 characters (HEX values from 0x00 to 0xFF). To set a bad read message, scan the **Set Bad Read Message** barcode, the numeric barcodes representing the hexadecimal values of desired character(s) and the **Save** barcode. The default setting is “NG”.



@NGRSET  
**Set Bad Read Message**

**E**  
*sample*

**Set the bad read message to “F” (HEX: 0x46):**

1. Scan the **Enter Setup** barcode.
2. Scan the **Set Bad Read Message** barcode.
3. Scan the numeric barcodes “4” and “6” from the “Digit Barcodes” section in Appendix.
4. Scan the **Save** barcode from the “Save/Cancel Barcodes” section in Appendix.
5. Scan the **Exit Setup** barcode.



@SETUPE0  
**\*\* Exit Setup**



@SETUPE1  
Enter Setup

---

## Default Settings

### Factory Defaults

Scanning the following barcode can restore the scanner to the factory defaults.

You may need to reset all parameters to the factory defaults when:

- ✧ scanner is not properly configured so that it fails to decode barcodes.
- ✧ you forget previous configuration and want to avoid its impact.



@FACDEF  
**Restore All Factory Defaults**

### Custom Defaults

Scanning the **Restore All Custom Defaults** barcode can reset all parameters to the custom defaults. Scanning the **Save as Custom Defaults** barcode can set the current settings as custom defaults.

Custom defaults are stored in the non-volatile memory.



@CUSSAV  
**Save as Custom Defaults**



@CUSDEF  
**Restore All Custom Defaults**



Restoring the scanner to the factory defaults will not remove the custom defaults from the scanner.



@SETUPE0  
**\*\* Exit Setup**



@SETUPE1  
**Enter Setup**

---

## Query Product Information

After scanning the barcode below, the product information (including product name, firmware version, decoder version, hardware version, product serial number, OEM serial number and manufacturing date) will be sent to the host device.



@QRYSYS  
**Query Product Information**

## Query Product Name



@QRYPDN  
**Query Product Name**

## Query Firmware Version



@QRYFWV  
**Query Firmware Version**



@SETUPE0  
**\*\* Exit Setup**



@SETUPE1  
Enter Setup

---

### Query Decoder Version



@QRYDCV  
Query Decoder Version

### Query Hardware Version



@QRYHWW  
Query Hardware Version

### Query Product Serial Number



@QRYPSN  
Query Product Serial Number



@SETUPE0  
\*\* Exit Setup



@SETUPE1  
Enter Setup

---

### Query Manufacturing Date



@QRYDAT  
Query Manufacturing Date

### Query OEM Serial Number



@QRYESN  
Query OEM Serial Number

### Query Data Formatter Version



@QRYDFM  
Query Data Formatter Version



@SETUPE0  
\*\* Exit Setup



@SETUPE1  
Enter Setup

## Chapter 4 RS-232 Interface

### Introduction

When the scanner is connected to the RS-232 port of a host device, the scanner will automatically enable RS-232 communication. However, you need to set communication parameters (including baud rate, parity check, data bit and stop bit) on the scanner to match the host device so that two devices can communicate with each other.



@INTERF0  
RS-232



@SETUPE0  
\*\* Exit Setup





@SETUPE1  
Enter Setup

---

## Baud Rate

Baud rate is the number of bits of data transmitted per second. Set the baud rate to match the host requirements.



@232BAD8  
115200



@232BAD7  
57600

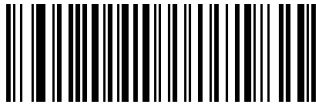

@232BAD6  
38400



@232BAD5  
19200



@232BAD4  
14400



@232BAD3  
\*\* 9600



@232BAD2  
4800



@232BAD1  
2400

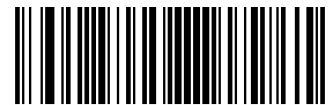

@SETUPE0  
\*\* Exit Setup



@SETUPE1

Enter Setup

---

## Parity Check

Set the parity type to match the host requirements.

- ◇ **Odd Parity:** If the data contains an odd number of 1 bits, the parity bit value is set to 0.
- ◇ **Even Parity:** If the data contains an even number of 1 bits, the parity bit value is set to 0.
- ◇ **None:** Select this option when no parity bit is required.



@232PAR0

\*\* None



@232PAR1

Even Parity



@232PAR2

Odd Parity



@SETUPE0

\*\* Exit Setup



@SETUPE1  
**Enter Setup**

---

## Data Bit

Set the number of data bits to match the host requirements.



@232DAT1  
**7 Data Bits**



@232DAT0  
**\*\* 8 Data Bits**

## Stop Bit

The stop bit(s) at the end of each transmitted character marks the end of transmission of one character and prepares the receiving device for the next character in the serial data stream. Set the number of stop bits to match the host requirements.



@232STP0  
**\*\* 1 Stop Bit**



@232STP1  
**2 Stop Bits**



@SETUPE0  
**\*\* Exit Setup**



@SETUPE1  
Enter Setup

---

## Hardware Auto Flow Control

If this feature is enabled, the scanner determines whether to transmit data based on CTS signal level. When CTS signal is at a low level which means the serial port's cache memory of receiving device (such as PC) is full, the scanner sends data through RS-232 port until CTS signal is set to high level by receiving device. When the scanner is not ready for receiving, it will set RTS signal to low level. When sending device (such as PC) detects it, it will not send data to the scanner any more to prevent data loss.

If this feature is disabled, reception/transmission of serial data will not be influenced by RTS/CTS signal.



@232AFL0

**\*\* Disable Hardware Auto Flow Control**



@232AFL1

**Enable Hardware Auto Flow Control**



Before enabling this feature, make sure that RTS/CTS signal lines are contained in RS-232 cable. Without the signal lines, RS-232 communication errors will occur.



@SETUPE0  
**\*\* Exit Setup**



@SETUPE1  
**Enter Setup**

---

## Datalogic Magellan Aux-RS232

Scanning the following barcode to program the scanner for a Datalogic Magellan Aux-RS232 port configuration.



@INTERF14  
**Datalogic Magellan Aux-RS232**

**Note:** A specific data cable is necessary for the Datalogic Magellan Aux-RS232 port. Please contact salesperson to buy CBL-125R or CBL-128R cable.

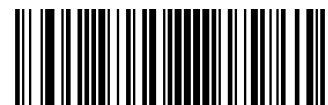

@SETUPE0  
**\*\* Exit Setup**



@SETUPE1  
Enter Setup

## Chapter 5 USB Interface

### Introduction

There are four options for USB connection:

- ✧ USB HID Keyboard: The scanner's transmission is simulated as USB keyboard input with no need for command configuration or a driver. Barcode data could be entered by the virtual keyboard directly and it is also convenient for the host device to receive data.
- ✧ USB CDC: It is compliant with the standard USB CDC class specifications defined by the USB-IF and allows the host device to receive data in the way as a serial port does. A driver is needed when using this feature.
- ✧ HID POS (POS HID Barcode Scanner): It is based on the HID interface, with no need for a custom driver. It excels virtual keyboard and traditional RS-232 interface in transmission speed.
- ✧ IBM SurePOS: It conforms to IBM (now Toshiba Global Commerce Solutions) 4698 USB scanner interface specifications.

When the scanner is connected to both USB and RS-232 ports on a host device, it will select the USB connection by default.



@SETUPE0  
\*\* Exit Setup



@SETUPE1  
**Enter Setup**

---

## USB HID Keyboard

When the scanner is connected to the USB port on a host device, you can enable the USB HID Keyboard feature by scanning the barcode below. Then scanner's transmission will be simulated as USB keyboard input. The Host receives keystrokes on the virtual keyboard. It works on a Plug and Play basis and no driver is required.



@INTERF3  
**\*\* USB HID Keyboard**



If the host device allows keyboard input, then no extra software is needed for HID Keyboard input.

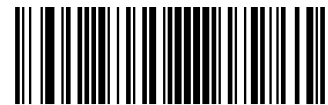

@SETUPE0  
**\*\* Exit Setup**



@SETUPE1  
**Enter Setup**

---

## USB Country Keyboard Types

Keyboard layouts vary from country to country. The default setting is U.S. keyboard.

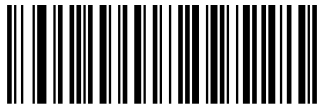

@KBWCTY0  
**\*\* U.S. (English)**



@KBWCTY2  
**Brazil**



@KBWCTY4  
**Czechoslovakia**



@KBWCTY6  
**Finland (Swedish)**



@KBWCTY1  
**Belgium**



@KBWCTY3  
**Canada (French)**



@KBWCTY5  
**Denmark**



@SETUPE0  
**\*\* Exit Setup**





@SETUPE1  
**Enter Setup**

---



@KBWCTY7  
**France**



@KBWCTY8  
**Germany/ Austria**



@KBWCTY9  
**Greece**

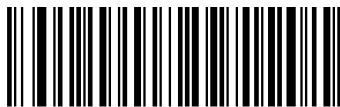

@KBWCTY10  
**Hungary**



@KBWCTY11  
**Israel (Hebrew)**

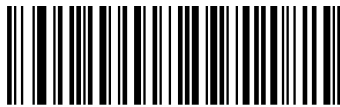

@KBWCTY12  
**Italy**



@KBWCTY13  
**Latin America/ South America**

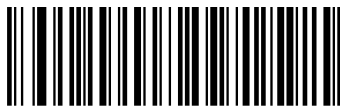

@KBWCTY14  
**Netherlands (Dutch)**



@SETUPE0  
**\*\* Exit Setup**



@SETUPE1  
**Enter Setup**

---



@KBWCTY15  
**Norway**



@KBWCTY16  
**Poland**



@KBWCTY17  
**Portugal**



@KBWCTY18  
**Romania**



@KBWCTY19  
**Russia**



@KBWCTY21  
**Slovakia**



@KBWCTY22  
**Spain**



@KBWCTY23  
**Sweden**



@SETUPE0  
**\*\* Exit Setup**



@SETUPE1  
**Enter Setup**

---



@KBWCTY24  
**Switzerland (German)**



@KBWCTY25  
**Turkey\_F**



@KBWCTY26  
**Turkey\_Q**

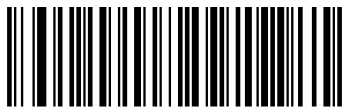

@KBWCTY27  
**UK**



@KBWCTY28  
**Japan**



@SETUPE0  
**\*\* Exit Setup**



@SETUPE1  
Enter Setup

---

### Beep on Unknown Character

Due to the differences in keyboard layouts, some characters contained in barcode data may be unavailable on the selected keyboard. As a result, the scanner fails to transmit the unknown characters.

Scan the appropriate barcode below to enable or disable the emission of beep when an unknown character is detected.



@KBWBUC0

**\*\* Do Not Beep on Unknown Character**



@KBWBUC1

**Beep on Unknown Character**

**E**  
*sample*

Supposing French keyboard (Country Code: 7) is selected and barcode data "ADF" is being dealt with, the keyboard will fail to locate the "D" (0xD0) character and the scanner will ignore the character and continue to process the next one.

**Do Not Beep on Unknown Character:** The scanner does not beep and the Host receives "AF".

**Beep on Unknown Character:** The scanner beeps and the Host still receives "AF".



If **Emulate ALT+Keypad ON** is selected, **Beep on Unknown Character** does not function.



@SETUPE0  
**\*\* Exit Setup**



@SETUPE1  
Enter Setup

## Emulate ALT+Keypad

When **Emulate ALT+Keypad** is turned on, any character whose ASCII value is greater than or equal to 0x20 is sent over the numeric keypad no matter which keyboard type is selected.

1. ALT Make
2. Enter the number corresponding to a desired character on the keypad.
3. ALT Break

After **Emulate ALT+Keypad ON** is selected, you need to choose the code page with which the barcodes were created and to turn **Unicode Encoding** On or Off depending on the encoding used by the application software.

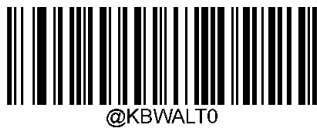

\*\* Emulate ALT+Keypad OFF

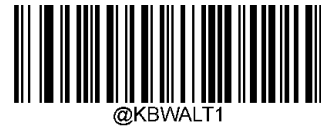

Emulate ALT+Keypad ON



Since sending a character involves multiple keystroke emulations, this method appears less efficient.



Supposing **Emulate ALT+Keypad** is ON, **Unicode Encoding** is Off, **Code Page 1252 (West European Latin)** is selected, and **Emulate Keypad with Leading Zero** is Off, barcode data "ADF" (65/208/70) is sent as below:

"A" -- "ALT Make" + "065" + "ALT Break"

"D" -- "ALT Make" + "208" + "ALT Break"

"F" -- "ALT Make" + "070" + "ALT Break"

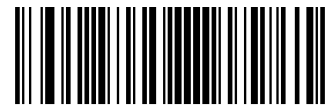

@SETUPE0  
\*\* Exit Setup



@SETUPE1  
Enter Setup

---

## Code Page

Code pages define the mapping of character codes to characters. If the data received does not display with the proper characters, it may be because the barcode being scanned was created using a code page that is different from the one the host program is expecting. If this is the case, select the code page with which the barcodes were created by scanning the appropriate barcode below. For PDF417, QR Code, Aztec and Data Matrix, besides setting the code page, you also need to set the character encoding in the “Character Encoding” section in Chapter 6. This feature is only effective when **Emulate ALT+Keypad** is turned on.



@KBWCPG0

\*\* Code Page 1252 (West European Latin)



@KBWCPG1

Code Page 1251 (Cyrillic)



@KBWCPG2

Code Page 1250 (Central and East European Latin)



@KBWCPG3

Code Page 1253 (Greek)



@KBWCPG4

Code Page 1254 (Turkish)



@KBWCPG5

Code Page 1255 (Hebrew)



@SETUPE0

\*\* Exit Setup



@SETUPE1  
**Enter Setup**

---



@KBWCPG6  
**Code Page 1256 (Arabic)**



@KBWCPG7  
**Code Page 1257 (Baltic)**



@KBWCPG8  
**Code Page 1258 (Vietnamese)**



@KBWCPG9  
**Code Page 936 (Simplified Chinese, GB2312,GBK)**



@KBWCPG10  
**Code Page 950 (Traditional Chinese, Big5)**



@KBWCPG12  
**Code Page 932 (Japanese, Shift-JIS)**

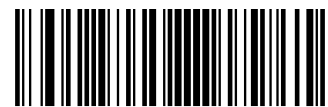

---

@SETUPE0  
**\*\* Exit Setup**



@SETUPE1  
Enter Setup

---

### Unicode Encoding

Different host program may use different character encodings for handling incoming barcode data. For instance, Microsoft Office Word uses Unicode encoding and therefore you should turn **Unicode Encoding** on, whereas Microsoft Office Excel or Notepad uses Code Page encoding and therefore you should turn **Unicode Encoding** off. This feature is only effective when **Emulate ALT+Keypad** is turned on.



@KBWCPU0  
\*\* Off



@KBWCPU1  
On

### Emulate Keypad with Leading Zero

You may turn this feature on to send character sequences sent over the numeric keypad as ISO characters which have a leading zero. For example, ASCII A transmits as "ALT MAKE" 0065 "ALT BREAK". This feature is only effective when **Emulate ALT+Keypad** is enabled.



@KBWALZ1  
\*\* On



@KBWALZ0  
Off



@SETUPE0  
\*\* Exit Setup





@SETUPE1  
Enter Setup

## Function Key Mapping

When **Ctrl+ASCII Mode** is selected, function characters (0x00 - 0x1F) are sent as ASCII sequences.



@KBWFKM0  
\*\* Disable



@KBWFKM1  
Ctrl+ASCII Mode



@KBWFKM2  
Alt+Keypad Mode

## Example

If **Ctrl+ASCII Mode** is selected and other parameters of USB HID Keyboard adopt factory defaults, barcode data “A<HT>(i.e. Horizontal Tab)F” (0x41/0x09/0x46) is sent as below:

- “A” - Keystroke “A”
- <HT> - “Ctrl Make” + Keystroke “I” + “Ctrl Break”
- “F” - Keystroke “F”

For some text editors, “Ctrl I” means italic convert. So the output may be “A*F*”.

If **Alt+Keypad Mode** is selected and other parameters of USB HID Keyboard adopt factory defaults, the data above is sent as below:

- “A” - Keystroke “A”
- <HT> - “Alt Make” + Keystrokes “009” + “Alt Break”
- “F” - Keystroke “F”

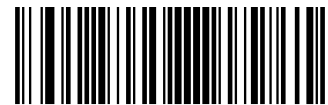

@SETUPE0  
\*\* Exit Setup



@SETUPE1  
Enter Setup

### ASCII Function Key Mapping Table

ASCII Function	ASCII Value (HEX)	Function Key Mapping Disabled	Ctrl+ASCII
NUL	00	Null	Ctrl+@
SOH	01	Keypad Enter	Ctrl+A
STX	02	Caps Lock	Ctrl+B
ETX	03	ALT	Ctrl+C
EOT	04	Null	Ctrl+D
ENQ	05	CTRL	Ctrl+E
ACK	06	Null	Ctrl+F
BEL	07	Enter	Ctrl+G
BS	08	Left Arrow	Ctrl+H
HT	09	Horizontal Tab	Ctrl+I
LF	0A	Down Arrow	Ctrl+J
VT	0B	Vertical Tab	Ctrl+K
FF	0C	Delete	Ctrl+L
CR	0D	Enter	Ctrl+M
SO	0E	Insert	Ctrl+N
SI	0F	Esc	Ctrl+O
DLE	10	F11	Ctrl+P
DC1	11	Home	Ctrl+Q
DC2	12	PrintScreen	Ctrl+R
DC3	13	Backspace	Ctrl+S
DC4	14	tab+shift	Ctrl+T
NAK	15	F12	Ctrl+U
SYN	16	F1	Ctrl+V
ETB	17	F2	Ctrl+W
CAN	18	F3	Ctrl+X
EM	19	F4	Ctrl+Y
SUB	1A	F5	Ctrl+Z
ESC	11	F6	Ctrl+[
FS	1C	F7	Ctrl+\
GS	1D	F8	Ctrl+]
RS	1E	F9	Ctrl+6
US	1F	F10	Ctrl+-



@SETUPE0  
\*\* Exit Setup



@SETUPE1  
Enter Setup

### ASCII Function Key Mapping Table (Continued)

The last five characters (0x1B~0x1F) in the table above apply to US keyboard layout only. The following chart provides the equivalents of these five characters for other countries.

Country	Ctrl+ASCII					
United States	Ctrl+[	Ctrl+\	Ctrl+]	Ctrl+6	Ctrl+-	
Belgium	Ctrl+[	Ctrl+<	Ctrl+]	Ctrl+6	Ctrl+-	
Scandinavia	Ctrl+8	Ctrl+<	Ctrl+9	Ctrl+6	Ctrl+-	
France	Ctrl+^	Ctrl+8	Ctrl+\$	Ctrl+6	Ctrl+=	
Germany		Ctrl+Ã	Ctrl++	Ctrl+6	Ctrl+-	
Italy		Ctrl+\	Ctrl++	Ctrl+6	Ctrl+-	
Switzerland		Ctrl+<	Ctrl+..	Ctrl+6	Ctrl+-	
United Kingdom	Ctrl+[	Ctrl+∅	Ctrl+]	Ctrl+6	Ctrl+-	
Denmark	Ctrl+8	Ctrl+\	Ctrl+9	Ctrl+6	Ctrl+-	
Norway	Ctrl+8	Ctrl+\	Ctrl+9	Ctrl+6	Ctrl+-	
Spain	Ctrl+[	Ctrl+\	Ctrl+]	Ctrl+6	Ctrl+-	



@SETUPE0  
\*\* Exit Setup



@SETUPE1  
**Enter Setup**

---

## Inter-Keystroke Delay

This parameter specifies the delay between emulated keystrokes.



@KBWDLY0  
**\*\* No Delay**



@KBWDLY40  
**Long Delay (40ms)**



@KBWDLY20  
**Short Delay (20ms)**



@SETUPE0  
**\*\* Exit Setup**



@SETUPE1  
Enter Setup

## Caps Lock

The **Caps Lock On** options can invert upper and lower case characters contained in barcode data. This inversion occurs regardless of the state of Caps Lock key on the host device's keyboard. To disable this feature, scan the appropriate **Caps Lock OFF** barcode below based on your keyboard.



@KBWCAP0

\*\* Caps Lock OFF, Non-Japanese Keyboard



@KBWCAP1

Caps Lock ON, Non-Japanese Keyboard

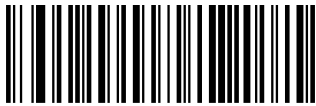

@KBWCAP2

Caps Lock OFF, Japanese Keyboard



@KBWCAP3

Caps Lock ON, Japanese Keyboard



Emulate ALT+Keypad ON/ Convert All to Upper Case/ Convert All to Lower Case prevails over Caps Lock ON.



When the **Caps Lock ON** feature is selected, barcode data "AbC" is transmitted as "aBc".



@SETUPE0  
\*\* Exit Setup



@SETUPE1  
Enter Setup

---

## Convert Case

Scan the appropriate barcode below to convert all bar code data to your desired case.



@KBWCAS0  
**\*\* No Case Conversion**



@KBWCAS1  
**Convert All to Upper Case**



@KBWCAS2  
**Convert All to Lower Case**

**E**  
*xample*

When the **Convert All to Lower Case** feature is enabled, barcode data “AbC” is transmitted as “abc”.



If **Emulate ALT+Keypad ON** is selected, **Convert All to Lower Case** and **Convert All to Upper Case** do not function.



@SETUPE0  
**\*\* Exit Setup**



@SETUPE1  
Enter Setup

## Emulate Numeric Keypad



- ◇ **Do Not Emulate Numeric Keypad 1:** Sending a number (0-9) is emulated as keystroke(s) on main keyboard.
- ◇ **Emulate Numeric Keypad 1:** Sending a number (0-9) is emulated as keystroke(s) on numeric keypad. The state of Num Lock on the simulated numeric keypad is determined by its equivalent on the host device. If Num Lock on the host device is turned off, the output of simulated numeric keypad is function key instead of number.
- ◇ **Do Not Emulate Numeric Keypad 2:** Sending “+”, “-”, “\*” and “/” is emulated as keystroke(s) on main keyboard.
- ◇ **Emulate Numeric Keypad 2:** Sending “+”, “-”, “\*” and “/” is emulated as keystroke(s) on numeric keypad.



@KBWNUM0

**\*\* Do Not Emulate Numeric Keypad 1**



@KBWNUM1

**Emulate Numeric Keypad 1**



@SETUPE0

**\*\* Exit Setup**



@SETUPE1  
**Enter Setup**

---



@KBWNCH0  
**\*\* Do Not Emulate Numeric Keypad 2**



@KBWNCH1  
**Emulate Numeric Keypad 2**



**Emulate ALT+Keypad ON** prevails over **Emulate Numeric Keypad**.

## **E** *xample*

Supposing the **Emulate Numeric Keypad 1** feature is enabled:

if Num Lock on the host device is ON, "A4.5" is transmitted as "A4.5";

if Num Lock on the host device is OFF, "A4.5" is transmitted as ".A":

1. "A" is sent on main keyboard;
2. "4" is sent as the function key "Cursor Move to Left";
3. "." is sent on main keyboard;
4. "5" is not sent as it does not correspond to any function key.



@SETUPE0  
**\*\* Exit Setup**





@SETUPE1  
**Enter Setup**

---

## Fast Mode

When **Fast Mode On** is selected, the scanner sends characters to the Host faster. If the Host drops characters, turn the Fast Mode off or change the polling rate to a bigger value.



@KBWFAS0  
**\*\* Fast Mode Off**



@KBWFAS1  
**Fast Mode On**



@SETUPE0  
**\*\* Exit Setup**



@SETUPE1  
Enter Setup

---

## Polling Rate

This parameter specifies the polling rate for a USB keyboard. If the Host drops characters, change the polling rate to a bigger value.



@KBWPOR0  
1ms



@KBWPOR1  
2ms



@KBWPOR2  
3ms



@KBWPOR3  
\*\* 4ms



@KBWPOR4  
5ms



@KBWPOR5  
6ms



@KBWPOR6  
7ms



@SETUPE0  
\*\* Exit Setup



@SETUPE1  
**Enter Setup**

---



@KBWPOR7  
**8ms**



@KBWPOR8  
**9ms**

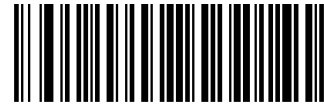

@KBWPOR9  
**10ms**



@SETUPE0  
**\*\* Exit Setup**



@SETUPE1  
**Enter Setup**

---

## USB CDC

If your scanner is connected to the USB port on a host device, the USB CDC feature allows the host device to receive data in the way as a serial port does. A driver is needed when using this feature. You may download it from our website at [www.newlandaidc.com](http://www.newlandaidc.com).



@INTERF8  
**USB CDC**



@SETUPE0  
**\*\* Exit Setup**



@SETUPE1  
**Enter Setup**

---

## HID POS (POS HID Barcode Scanner)

### Introduction

The HID-POS interface is recommended for new application programs. It can send up to 56 characters in a single USB report and appears more efficient than keyboard emulation.

Features:

- ✧ HID based, no custom driver required.
- ✧ Way more efficient in communication than keyboard emulation and traditional RS-232 interface.



@INTERF5  
**USB HID-POS**

### Access the Scanner with Your Program

Use CreateFile to access the scanner as a HID device and then use ReadFile to deliver the scanned data to the application program. Use WriteFile to send data to the scanner.

For detailed information about USB and HID interfaces, go to [www.USB.org](http://www.USB.org).



@SETUPE0  
**\*\* Exit Setup**



@SETUPE1  
Enter Setup

### Acquire Scanned Data

After a barcode is decoded, the scanner sends an input report as below:

	Bit							
Byte	7	6	5	4	3	2	1	0
0	Report ID = 0x02							
1	Barcode Length							
2-57	Decoded Data (1-56)							
58-61	Reserved							
62	Newland Symbology Identifier or N/C: 0x00							
63	-	-	-	-	-	-	-	Decoded data continued

### Send Command to the Scanner

This output report is used to send commands to the scanner. All programming commands can be used.

	Bit							
Byte	7	6	5	4	3	2	1	0
0	Report ID = 0x04							
1	Length of command							
2-63	Command (1-62)							



@SETUPE0  
\*\* Exit Setup



@SETUPE1  
Enter Setup

## IBM SurePOS (Tabletop)



@INTERF6

IBM SurePOS (Tabletop)

## IBM SurePOS (Handheld)



@INTERF7

IBM SurePOS (Handheld)

## VID/PID

USB uses VID (Vendor ID) and PID (Product ID) to identify and locate a device. The VID is assigned by USB Implementers Forum. Newland's vendor ID is 1EAB (Hex). A range of PIDs are used for each Newland product family. Every PID contains a base number and interface type (keyboard, COM port, etc.).

Product	Interface	PID (Hex)	PID (Dec)
FM430	USB HID Keyboard	1D22	7458
	USB CDC	1D06	7430
	HID POS	1D10	7440
	IBM SurePOS (Tabletop)	1D20	7456
	IBM SurePOS(Handheld)	1D21	7457

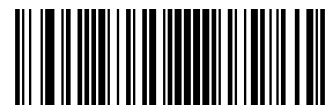

@SETUPE0  
\*\* Exit Setup



@SETUPE1  
**Enter Setup**

---

## Adaptive Wired Communication

When this feature is on, the scanner can automatically adapt its communication configuration to the way it is connected to the host device: Automatically enable USB/serial communication when connected to the host device via USB/serial port, respectively.

Note: You must restart the scanner before this setting will take effect.



@AUTOUR0  
**Off**



@AUTOUR1  
**\*\* On**



@SETUPE0  
**\*\* Exit Setup**





@SETUPE1  
Enter Setup

# Chapter 6 Symbologies

## Introduction

Every symbology (barcode type) has its own unique attributes. This chapter provides programming barcodes for configuring the scanner so that it can identify various symbologies. It is recommended to disable those that are rarely used to increase the efficiency of the scanner.

## Global Settings

### Enable/Disable All Symbologies

If the **Disable All Symbologies** feature is enabled, the scanner will not be able to read any non-programming barcodes except the programming barcodes.



@ALLENA1  
Enable All Symbologies



@ALLENA0  
Disable All Symbologies

### Enable/Disable 1D Symbologies



@ALL1DC1  
Enable 1D Symbologies



@ALL1DC0  
Disable 1D Symbologies



@SETUPE0  
\*\* Exit Setup



@SETUPE1  
Enter Setup

---

### Enable/Disable 2D Symbologies



@ALL2DC1  
Enable 2D Symbologies



@ALL2DC0  
Disable 2D Symbologies

### Enable/Disable Postal Symbologies



@ALLPST1  
Enable All Postal Symbologies



@ALLPST0  
Disable All Postal Symbologies



@SETUPE0  
\*\* Exit Setup



@SETUPE1  
Enter Setup

## 1D Twin Code

1D twin code is two 1D barcodes of a symbology or of different symbologies paralleled vertically. Both barcodes must have similar specifications and be placed closely together.

There are 3 options for reading 1D twin code:

- ◇ **Single 1D Code Only:** Read either 1D code.
- ◇ **Twin 1D Code Only:** Read both 1D codes. Transmission sequence: upper 1D code followed by lower 1D code.
- ◇ **Both Single & Twin:** Read both 1D codes. If successful, transmit as twin 1D code only. Otherwise, try single 1D code only.



@A1DDOU0  
**\*\* Single 1D Code Only**



@A1DDOU2  
**Twin 1D Code Only**

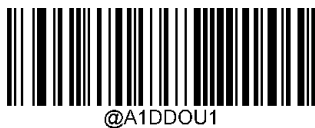

@A1DDOU1  
**Both Single & Twin**



@SETUPE0  
**\*\* Exit Setup**



@SETUPE1  
Enter Setup

---

### Surround GS1 Application Identifiers (AI's) with Parentheses

When **Surround GS1 AI's with Parentheses** is selected, each application identifier (AI) contained in scanned data will be enclosed in parentheses in the output message.



@GS1AIP0

**\*\* Do Not Surround GS1 AI's with Parentheses**



@GS1AIP1

**Surround GS1 AI's with Parentheses**

**E**  
*xample*

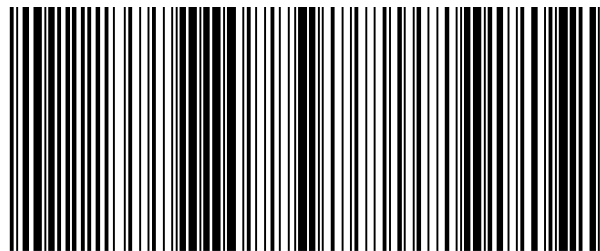

(01) 0 0614141 99999 6 (10) 10ABCEDF123456

If **Surround GS1 AI's with Parentheses** is selected, the barcode above is output as (01)00614141999996(10)10ABCEDF123456.

If **Do Not Surround GS1 AI's with Parentheses** is selected, the barcode above is output as 01006141419999961010ABCEDF123456.



@SETUPE0  
**\*\* Exit Setup**



@SETUPE1  
**Enter Setup**

## Code 128

### Restore Factory Defaults



@128DEF

**Restore the Factory Defaults of Code 128**

### Enable/Disable Code 128



@128ENA1

**\*\* Enable Code 128**



@128ENA0

**Disable Code 128**



If the scanner fails to identify Code 128 barcodes, you may first try this solution by scanning the **Enter Setup** barcode and then **Enable Code 128** barcode.



@SETUPE0

**\*\* Exit Setup**



@SETUPE1  
Enter Setup

## Set Length Range for Code 128

The scanner can be configured to only decode Code 128 barcodes with lengths that fall between (inclusive) the minimum and maximum lengths. To accomplish it, you need to set the minimum and maximum lengths.



@128MIN

**Set the Minimum Length (Default: 1)**



@128MAX

**Set the Maximum Length (Default: 48)**



If minimum length is set to be greater than maximum length, the scanner only decodes Code 128 barcodes with either the minimum or maximum length. If minimum length is same as maximum length, only Code 128 barcodes with that length are to be decoded.



### **Set the scanner to decode Code 128 barcodes containing between 8 and 12 characters:**

1. Scan the **Enter Setup** barcode.
2. Scan the **Set the Minimum Length** barcode.
3. Scan the numeric barcode "8" from the "Digit Barcodes" section in Appendix.
4. Scan the **Save** barcode from the "Save/Cancel Barcodes" section in Appendix.
5. Scan the **Set the Maximum Length** barcode.
6. Scan the numeric barcodes "1" and "2" from the "Digit Barcodes" section in Appendix.
7. Scan the **Save** barcode from the "Save/Cancel Barcodes" section in Appendix.
8. Scan the **Exit Setup** barcode.



@SETUPE0

**\*\* Exit Setup**



@SETUPE1  
Enter Setup

## EAN-8

### Restore Factory Defaults



@EA8DEF

Restore the Factory Defaults of EAN-8

### Enable/Disable EAN-8



@EA8ENA1

\*\* Enable EAN-8



@EA8ENA0

Disable EAN-8



If the scanner fails to identify EAN-8 barcodes, you may first try this solution by scanning the **Enter Setup** barcode and then **Enable EAN-8** barcode.

### Transmit Check Character

EAN-8 is 8 digits in length with the last one as its check character used to verify the integrity of the data.



@EA8CHK2

\*\* Transmit EAN-8 Check Character



@EA8CHK1

Do Not Transmit EAN-8 Check Character



@SETUPE0

\*\* Exit Setup



@SETUPE1  
Enter Setup

---

## 2-Digit Add-On Code

An EAN-8 barcode can be augmented with a two-digit add-on code to form a new one. In the example below, the part surrounded by blue dotted line is an EAN-8 barcode while the part circled by red dotted line is a two-digit add-on code.



@EA8AD20  
**\*\* Disable 2-Digit Add-On Code**



@EA8AD21  
**Enable 2-Digit Add-On Code**



**Disable 2-Digit Add-On Code:** The scanner decodes EAN-8 and ignores the add-on code when presented with an EAN-8 plus 2-digit add-on barcode. It can also decode EAN-8 barcodes without 2-digit add-on codes.

**Enable 2-Digit Add-On Code:** The scanner decodes a mix of EAN-8 barcodes with and without 2-digit add-on codes.



@SETUPE0  
**\*\* Exit Setup**





@SETUPE1  
Enter Setup

### 5-Digit Add-On Code

An EAN-8 barcode can be augmented with a five-digit add-on code to form a new one. In the example below, the part surrounded by blue dotted line is an EAN-8 barcode while the part circled by red dotted line is a five-digit add-on code.



**\*\* Disable 5-Digit Add-On Code**



**Enable 5-Digit Add-On Code**



**Disable 5-Digit Add-On Code:** The scanner decodes EAN-8 and ignores the add-on code when presented with an EAN-8 plus 5-digit add-on barcode. It can also decode EAN-8 barcodes without 5-digit add-on codes.

**Enable 5-Digit Add-On Code:** The scanner decodes a mix of EAN-8 barcodes with and without 5-digit add-on codes.

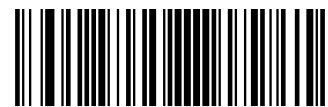

@SETUPE0  
**\*\* Exit Setup**



@SETUPE1  
Enter Setup

---

### Add-On Code Required

When **EAN-8 Add-On Code Required** is selected, the scanner will only read EAN-8 barcodes that contain add-on codes.



\*\* EAN-8 Add-On Code Not Required



**EAN-8 Add-On Code Required**

### Convert EAN-8 to EAN-13

**Convert EAN-8 to EAN-13:** Convert EAN-8 decoded data to EAN-13 format before transmission. After conversion, the data follows EAN-13 format and is affected by EAN-13 programming selections (e.g., Check Character).

**Do Not Convert EAN-8 to EAN-13:** EAN-8 decoded data is transmitted as EAN-8 data, without conversion.



\*\* Do Not Convert EAN-8 to EAN-13



**Convert EAN-8 to EAN-13**



@SETUPE0  
\*\* Exit Setup



@SETUPE1  
**Enter Setup**

---

## EAN-13

### Restore Factory Defaults



@E13DEF  
**Restore the Factory Defaults of EAN-13**

### Enable/Disable EAN-13



@E13ENA1  
**\*\* Enable EAN-13**



@E13ENA0  
**Disable EAN-13**



If the scanner fails to identify EAN-13 barcodes, you may first try this solution by scanning the **Enter Setup** barcode and then **Enable EAN-13** barcode.



@SETUPE0  
**\*\* Exit Setup**



@SETUPE1  
Enter Setup

### Transmit Check Character



@E13CHK2

\*\* Transmit EAN-13 Check Character



@E13CHK1

Do Not Transmit EAN-13 Check Character

### 2-Digit Add-On Code

An EAN-13 barcode can be augmented with a two-digit add-on code to form a new one. In the example below, the part surrounded by blue dotted line is an EAN-13 barcode while the part circled by red dotted line is a two-digit add-on code.



@E13AD20

\*\* Disable 2-Digit Add-On Code



@E13AD21

Enable 2-Digit Add-On Code



**Disable 2-Digit Add-On Code:** The scanner decodes EAN-13 and ignores the add-on code when presented with an EAN-13 plus 2-digit add-on barcode. It can also decode EAN-13 barcodes without 2-digit add-on codes.

**Enable 2-Digit Add-On Code:** The scanner decodes a mix of EAN-13 barcodes with and without 2-digit add-on codes.



@SETUPE0  
\*\* Exit Setup



@SETUPE1  
Enter Setup

### 5-Digit Add-On Code

An EAN-13 barcode can be augmented with a five-digit add-on code to form a new one. In the example below, the part surrounded by blue dotted line is an EAN-13 barcode while the part circled by red dotted line is a five-digit add-on code.



**\*\* Disable 5-Digit Add-On Code**



**Enable 5-Digit Add-On Code**



**Disable 5-Digit Add-On Code:** The scanner decodes EAN-13 and ignores the add-on code when presented with an EAN-13 plus 5-digit add-on barcode. It can also decode EAN-13 barcodes without 5-digit add-on codes.

**Enable 5-Digit Add-On Code:** The scanner decodes a mix of EAN-13 barcodes with and without 5-digit add-on codes.

### Add-On Code Required

When **EAN-13 Add-On Code Required** is selected, the scanner will only read EAN-13 barcodes that contain add-on codes.



**\*\* EAN-13 Add-On Code Not Required**



**EAN-13 Add-On Code Required**



@SETUPE0  
**\*\* Exit Setup**



@SETUPE1  
Enter Setup

### EAN-13 Beginning with 290 Add-On Code Required

This setting programs the scanner to require an add-on code (2-digit or 5-digit) on EAN-13 barcodes that begin with “290”. The following settings can be programmed:

**Require Add-On Code:** All EAN-13 barcodes that begin with “290” must have a 2-digit or 5-digit add-on code. The EAN-13 barcode with the add-on code is then transmitted. If the required add-on code is not found, the EAN-13 barcode is discarded.

**Do Not Require Add-On Code:** If you have selected **Require Add-On Code**, and you want to disable this feature, scan **Do Not Require Add-On Code**. EAN-13 barcodes are handled, depending on your selection for the “Add-On Code Required” feature.

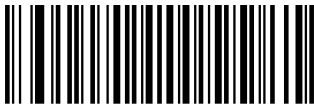

@E132900

**\*\* Do Not Require Add-On Code**



@E132901

**Require Add-On Code**

### EAN-13 Beginning with 378/379 Add-On Code Required

This setting programs the scanner to require an add-on code (2-digit or 5-digit) on EAN-13 barcodes that begin with a “378” or “379”. The following settings can be programmed:

**Require Add-On Code:** All EAN-13 barcodes that begin with a “378” or “379” must have a 2-digit or 5-digit add-on code. The EAN-13 barcode with the add-on code is then transmitted. If the required add-on code is not found, the EAN-13 barcode is discarded.

**Do Not Require Add-On Code:** If you have selected **Require Add-On Code**, and you want to disable this feature, scan **Do Not Require Add-On Code**. EAN-13 barcodes are handled, depending on your selection for the “Add-On Code Required” feature.



@E133780

**\*\* Do Not Require Add-On Code**



@E133781

**Require Add-On Code**



@SETUPE0  
**\*\* Exit Setup**



@SETUPE1  
Enter Setup

### EAN-13 Beginning with 414/419 Add-On Code Required

This setting programs the scanner to require an add-on code (2-digit or 5-digit) on EAN-13 barcodes that begin with a “414” or “419”. The following settings can be programmed:

**Require Add-On Code:** All EAN-13 barcodes that begin with a “414” or “419” must have a 2-digit or 5-digit add-on code. The EAN-13 barcode with the add-on code is then transmitted. If the required add-on code is not found, the EAN-13 barcode is discarded.

**Do Not Require Add-On Code:** If you have selected **Require Add-On Code**, and you want to disable this feature, scan **Do Not Require Add-On Code**. EAN-13 barcodes are handled, depending on your selection for the “Add-On Code Required” feature.



\*\* Do Not Require Add-On Code



Require Add-On Code

### EAN-13 Beginning with 434/439 Add-On Code Required

This setting programs the scanner to require an add-on code (2-digit or 5-digit) on EAN-13 barcodes that begin with a “434” or “439”. The following settings can be programmed:

**Require Add-On Code:** All EAN-13 barcodes that begin with a “434” or “439” must have a 2-digit or 5-digit add-on code. The EAN-13 barcode with the add-on code is then transmitted. If the required add-on code is not found, the EAN-13 barcode is discarded.

**Do Not Require Add-On Code:** If you have selected **Require Add-On Code**, and you want to disable this feature, scan **Do Not Require Add-On Code**. EAN-13 barcodes are handled, depending on your selection for the “Add-On Code Required” feature.



\*\* Do Not Require Add-On Code



Require Add-On Code

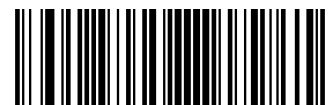

@SETUPE0  
\*\* Exit Setup



@SETUPE1  
Enter Setup

### EAN-13 Beginning with 977 Add-On Code Required

This setting programs the scanner to require an add-on code (2-digit or 5-digit) on EAN-13 barcodes that begin with “977”. The following settings can be programmed:

**Require Add-On Code:** All EAN-13 barcodes that begin with “977” must have a 2-digit or 5-digit add-on code. The EAN-13 barcode with the add-on code is then transmitted. If the required add-on code is not found, the EAN-13 barcode is discarded.

**Do Not Require Add-On Code:** If you have selected **Require Add-On Code**, and you want to disable this feature, scan **Do Not Require Add-On Code**. EAN-13 barcodes are handled, depending on your selection for the “Add-On Code Required” feature.



@E139770

**\*\* Do Not Require Add-On Code**



@E139771

**Require Add-On Code**

### EAN-13 Beginning with 978 Add-On Code Required

This setting programs the scanner to require an add-on code (2-digit or 5-digit) on EAN-13 barcodes that begin with “978”. The following settings can be programmed:

**Require Add-On Code:** All EAN-13 barcodes that begin with “978” must have a 2-digit or 5-digit add-on code. The EAN-13 barcode with the add-on code is then transmitted. If the required add-on code is not found, the EAN-13 barcode is discarded.

**Do Not Require Add-On Code:** If you have selected **Require Add-On Code**, and you want to disable this feature, scan **Do Not Require Add-On Code**. EAN-13 barcodes are handled, depending on your selection for the “Add-On Code Required” feature.



@E139780

**\*\* Do Not Require Add-On Code**



@E139781

**Require Add-On Code**



@SETUPE0  
**\*\* Exit Setup**





@SETUPE1  
Enter Setup

---

### EAN-13 Beginning with 979 Add-On Code Required

This setting programs the scanner to require an add-on code (2-digit or 5-digit) on EAN-13 barcodes that begin with “979”. The following settings can be programmed:

**Require Add-On Code:** All EAN-13 barcodes that begin with “979” must have a 2-digit or 5-digit add-on code. The EAN-13 barcode with the add-on code is then transmitted. If the required add-on code is not found, the EAN-13 barcode is discarded.

**Do Not Require Add-On Code:** If you have selected **Require Add-On Code**, and you want to disable this feature, scan **Do Not Require Add-On Code**. EAN-13 barcodes are handled, depending on your selection for the “Add-On Code Required” feature.



@E139790

**\*\* Do Not Require Add-On Code**



@E139791

**Require Add-On Code**

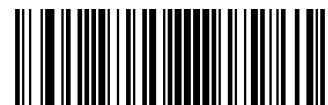

@SETUPE0

**\*\* Exit Setup**



@SETUPE1  
Enter Setup

---

## UPC-E

### Restore Factory Defaults



@UPEDEF  
Restore the Factory Defaults of UPC-E

### Enable/Disable UPC-E



@UPEEN01  
**\*\* Enable UPC-E0**



@UPEEN00  
**Disable UPC-E0**



@UPEEN11  
**Enable UPC-E1**



@UPEEN10  
**\*\* Disable UPC-E1**



If the scanner fails to identify UPC-E0/UPC-E1 barcodes, you may first try this solution by scanning the **Enter Setup** barcode and then **Enable UPC-E0/UPC-E1** barcode.



@SETUPE0  
**\*\* Exit Setup**



@SETUPE1  
Enter Setup

### Transmit Check Character

UPC-E is 8 digits in length with the last one as its check character used to verify the integrity of the data.



@UPECHK2

**\*\* Transmit UPC-E Check Character**



@UPECHK1

**Do Not Transmit UPC-E Check Character**

### 2-Digit Add-On Code

A UPC-E barcode can be augmented with a two-digit add-on code to form a new one. In the example below, the part surrounded by blue dotted line is a UPC-E barcode while the part circled by red dotted line is a two-digit add-on code.



@UPEAD20

**\*\* Disable 2-Digit Add-On Code**



@UPEAD21

**Enable 2-Digit Add-On Code**



**Disable 2-Digit Add-On Code:** The scanner decodes UPC-E and ignores the add-on code when presented with a UPC-E plus 2-digit add-on barcode. It can also decode UPC-E barcodes without 2-digit add-on codes.

**Enable 2-Digit Add-On Code:** The scanner decodes a mix of UPC-E barcodes with and without 2-digit add-on codes.

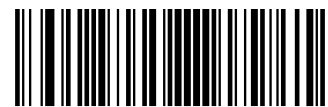

@SETUPE0

**\*\* Exit Setup**



@SETUPE1  
Enter Setup

### 5-Digit Add-On Code

A UPC-E barcode can be augmented with a five-digit add-on code to form a new one. In the example below, the part surrounded by blue dotted line is a UPC-E barcode while the part circled by red dotted line is a five-digit add-on code.

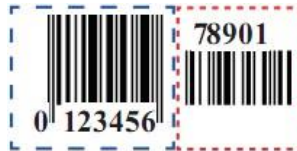

**\*\* Disable 5-Digit Add-On Code**



**Enable 5-Digit Add-On Code**



**Disable 5-Digit Add-On Code:** The scanner decodes UPC-E and ignores the add-on code when presented with a UPC-E plus 5-digit add-on barcode. It can also decode UPC-E barcodes without 5-digit add-on codes.

**Enable 5-Digit Add-On Code:** The scanner decodes a mix of UPC-E barcodes with and without 5-digit add-on codes.

### Add-On Code Required

When **UPC-E Add-On Code Required** is selected, the scanner will only read UPC-E barcodes that contain add-on codes.



**\*\* UPC-E Add-On Code Not Required**



**UPC-E Add-On Code Required**



@SETUPE0  
**\*\* Exit Setup**



@SETUPE1  
Enter Setup

### Transmit Preamble Character

Preamble characters (Country Code and System Character) can be transmitted as part of a UPC-E barcode. Select one of the following options for transmitting UPC-E preamble to the host device: transmit system character only, transmit system character and country code ("0" for USA), or transmit no preamble.



@UPEPRE1  
**\*\* System Character**



@UPEPRE0  
**No Preamble**

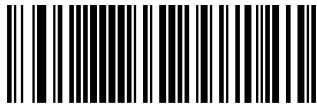

@UPEPRE2  
**System Character & Country Code**

### Convert UPC-E to UPC-A

**Convert UPC-E to UPC-A:** Convert UPC-E (zero suppressed) decoded data to UPC-A format before transmission. After conversion, the data follows UPC-A format and is affected by UPC-A programming selections (e.g., Preamble, Check Character).

**Do Not Convert UPC-E to UPC-A:** UPC-E decoded data is transmitted as UPC-E data, without conversion.



@UPEEXP0  
**\*\* Do Not Convert UPC-E to UPC-A**



@UPEEXP1  
**Convert UPC-E to UPC-A**



@SETUPE0  
**\*\* Exit Setup**



@SETUPE1  
Enter Setup

## UPC-A

### Restore Factory Defaults



@UPADEF  
Restore the Factory Defaults of UPC-A

### Enable/Disable UPC-A



@UPAENA1  
\*\* Enable UPC-A



@UPAENA0  
Disable UPC-A



If the scanner fails to identify UPC-A barcodes, you may first try this solution by scanning the **Enter Setup** barcode and then **Enable UPC-A** barcode.

### Transmit Check Character

UPC-A is 13 digits in length with the last one as its check character used to verify the integrity of the data.



@UPACHK2  
\*\* Transmit UPC-A Check Character



@UPACHK1  
Do Not Transmit UPC-A Check Character



@SETUPE0  
\*\* Exit Setup



@SETUPE1

Enter Setup

## 2-Digit Add-On Code

A UPC-A barcode can be augmented with a two-digit add-on code to form a new one. In the example below, the part surrounded by blue dotted line is a UPC-A barcode while the part circled by red dotted line is a two-digit add-on code.



@UPAAD20

**\*\* Disable 2-Digit Add-On Code**



@UPAAD21

**Enable 2-Digit Add-On Code**



**Disable 2-Digit Add-On Code:** The scanner decodes UPC-A and ignores the add-on code when presented with a UPC-A plus 2-digit add-on barcode. It can also decode UPC-A barcodes without 2-digit add-on codes.

**Enable 2-Digit Add-On Code:** The scanner decodes a mix of UPC-A barcodes with and without 2-digit add-on codes.

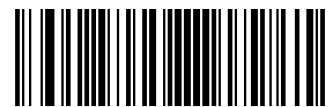

@SETUPE0

**\*\* Exit Setup**



@SETUPE1  
Enter Setup

---

### 5-Digit Add-On Code

A UPC-A barcode can be augmented with a five-digit add-on code to form a new one. In the example below, the part surrounded by blue dotted line is a UPC-A barcode while the part circled by red dotted line is a five-digit add-on code.



@UPAAD50  
**\*\* Disable 5-Digit Add-On Code**



@UPAAD51  
**Enable 5-Digit Add-On Code**



**Disable 5-Digit Add-On Code:** The scanner decodes UPC-A and ignores the add-on code when presented with a UPC-A plus 5-digit add-on barcode. It can also decode UPC-A barcodes without 5-digit add-on codes.

**Enable 5-Digit Add-On Code:** The scanner decodes a mix of UPC-A barcodes with and without 5-digit add-on codes.



@SETUPE0  
**\*\* Exit Setup**





@SETUPE1

Enter Setup

---

### Add-On Code Required

When **UPC-A Add-On Code Required** is selected, the scanner will only read UPC-A barcodes that contain add-on codes.



@UPAREQ0

**\*\* UPC-A Add-On Code Not Required**



@UPAREQ1

**UPC-A Add-On Code Required**

### Transmit Preamble Character

Preamble characters (Country Code and System Character) can be transmitted as part of a UPC-A barcode. Select one of the following options for transmitting UPC-A preamble to the host device: transmit system character only, transmit system character and country code ("0" for USA), or transmit no preamble.



@UPAPRE0

**\*\* No Preamble**

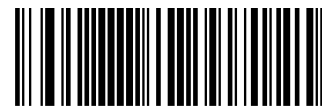

@UPAPRE1

**System Character**



@UPAPRE2

**System Character & Country Code**



@SETUPE0

**\*\* Exit Setup**



@SETUPE1  
Enter Setup

---

## Coupon

### UPC-A/EAN-13 with Extended Coupon Code

The following three types of coupon code + extended coupon code are supported:

- ✧ UPC-A (starting with “5”) + GS1-128
- ✧ UPC-A (starting with “5”) + GS1 Databar
- ✧ EAN-13 (starting with “99”) + GS1-128

Use the appropriate barcode below to enable or disable UPC-A/EAN-13 with Extended Coupon Code. When left on the default setting (**Off**), the scanner treats Coupon Codes and Extended Coupon Codes as single bar codes.

If you scan the **Allow Concatenation** code, when the scanner sees the coupon code and the extended coupon code in a single scan, it transmits both as separate symbologies. Otherwise, it transmits the first coupon code it reads.

If you scan the **Require Concatenation** code, the scanner must see and read the coupon code and extended coupon code in a single read to transmit the data. No data is output unless both codes are read.



@CPNENA0  
**\*\* Off**



@CPNENA1  
**Allow Concatenation**



@CPNENA2  
**Require Concatenation**



When using the UPC-A Coupon feature, please ensure that **System Character** or **System Character & Country Code** is selected for the “Transmit UPC-A Preamble Character” feature.



@SETUPE0  
**\*\* Exit Setup**



@SETUPE1  
Enter Setup

---

### Coupon GS1 Databar Output

If you scan coupons that have both UPC and GS1 Databar codes, you may wish to scan and output only the data from the GS1 Databar code. Scan the **GS1 Output On** barcode below to scan and output only the GS1 Databar code data.

When **GS1 Output Off** is selected, coupons that have both UPC and GS1 Databar codes are transmitted depending on your selection for the “UPC-A/EAN-13 with Extended Coupon Code” feature.



@CPNGS10  
**\*\* GS1 Output Off**



@CPNGS11  
**GS1 Output On**



When using the UPC-A Coupon feature, please ensure that **System Character** or **System Character & Country Code** is selected for the “Transmit UPC-A Preamble Character” feature.

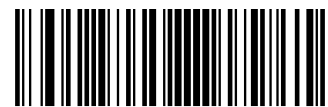

@SETUPE0  
**\*\* Exit Setup**



@SETUPE1  
Enter Setup

---

## Interleaved 2 of 5

### Restore Factory Defaults



@I25DEF

Restore the Factory Defaults of Interleaved 2 of 5

### Enable/Disable Interleaved 2 of 5



@I25ENA1

\*\* Enable Interleaved 2 of 5



@I25ENA0

Disable Interleaved 2 of 5



If the scanner fails to identify Interleaved 2 of 5 barcodes, you may first try this solution by scanning the **Enter Setup** barcode and then **Enable Interleaved 2 of 5** barcode.



@SETUPE0

\*\* Exit Setup



@SETUPE1  
Enter Setup

## Set Length Range for Interleaved 2 of 5

The scanner can be configured to only decode Interleaved 2 of 5 barcodes with lengths that fall between (inclusive) the minimum and maximum lengths. To accomplish it, you need to set the minimum and maximum lengths.



**Set the Minimum Length (Default: 6)**



**Set the Maximum Length (Default: 80)**



If minimum length is set to be greater than maximum length, the scanner only decodes Interleaved 2 of 5 barcodes with either the minimum or maximum length. If minimum length is same as maximum length, only Interleaved 2 of 5 barcodes with that length are to be decoded.



**Set the scanner to decode Interleaved 2 of 5 barcodes containing between 8 and 12 characters:**

1. Scan the **Enter Setup** barcode.
2. Scan the **Set the Minimum Length** barcode.
3. Scan the numeric barcode “8” from the “Digit Barcodes” section in Appendix.
4. Scan the **Save** barcode from the “Save/Cancel Barcodes” section in Appendix.
5. Scan the **Set the Maximum Length** barcode.
6. Scan the numeric barcodes “1” and “2” from the “Digit Barcodes” section in Appendix.
7. Scan the **Save** barcode from the “Save/Cancel Barcodes” section in Appendix.
8. Scan the **Exit Setup** barcode.



@SETUPE0  
\*\* Exit Setup



@SETUPE1  
Enter Setup

## Check Character Verification

A check character is optional for Interleaved 2 of 5 and can be added as the last character. It is a calculated value used to verify the integrity of the data.

- ✧ **Disable:** The scanner transmits Interleaved 2 of 5 barcodes as is.
- ✧ **Do Not Transmit Check Character After Verification:** The scanner checks the integrity of all Interleaved 2 of 5 barcodes to verify that the data complies with the check character algorithm. Barcodes passing the check will be transmitted except the last digit, whereas those failing it will not be transmitted.
- ✧ **Transmit Check Character After Verification:** The scanner checks the integrity of all Interleaved 2 of 5 barcodes to verify that the data complies with the check character algorithm. Barcodes passing the check will be transmitted, whereas those failing it will not be transmitted.

Since Interleaved 2 of 5 must always have an even number of digits, a zero may need to be added as the first digit when the check character is added. The check character is automatically generated when making Interleaved 2 of 5 barcodes.



@I25CHK0  
**\*\* Disable**



@I25CHK1

**Do Not Transmit Check Character After Verification**



@I25CHK2

**Transmit Check Character After Verification**



If the **Do Not Transmit Check Character After Verification** option is enabled, Interleaved 2 of 5 barcodes with a length that is less than the configured minimum length after having the check character excluded will not be decoded. (For example, when the **Do Not Transmit Check Character After Verification** option is enabled and the minimum length is set to 4, Interleaved 2 of 5 barcodes with a total length of 4 characters including the check character cannot be read.)



@SETUPE0  
**\*\* Exit Setup**



@SETUPE1  
Enter Setup

---

## Febraban

### Disable/Enable Febraban



@I25FBB0  
\*\* Disable Febraban



Enable Febraban, Expand



@I25FBB1  
Enable Febraban, Do Not Expand

### Transmit Delay per Character

**Transmit Delay per Character** applies to both Expanded and Unexpanded Febraban. This feature is available only when USB HID Keyboard is enabled.



\*\* Disable Transmit Delay per Character



@FEBSN1  
Enable Transmit Delay per Character



@SETUPE0  
\*\* Exit Setup



@SETUPE1  
**Enter Setup**

---

You may select an appropriate delay value from the options below as per your actual needs.



@FEBSDT0  
**0ms**



@FEBSDT5  
**5ms**

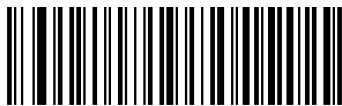

@FEBSDT10  
**10ms**



@FEBSDT15  
**15ms**



@FEBSDT20  
**20ms**



@FEBSDT25  
**25ms**

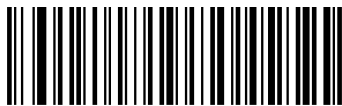

@FEBSDT30  
**30ms**



@FEBSDT35  
**35ms**



@SETUPE0  
**\*\* Exit Setup**





@SETUPE1  
**Enter Setup**

---

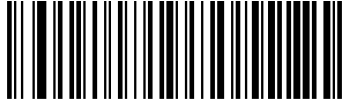

@FEBSDT40  
**40ms**



@FEBSDT45  
**45ms**

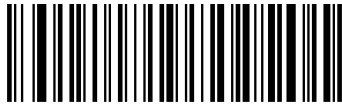

@FEBSDT50  
**50ms**



@FEBSDT55  
**55ms**

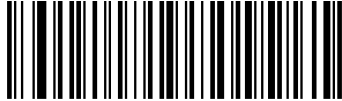

@FEBSDT60  
**60ms**



@FEBSDT65  
**65ms**



@FEBSDT70  
**\*\* 70ms**



@FEBSDT75  
**75ms**

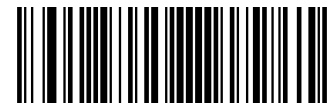

@SETUPE0  
**\*\* Exit Setup**



@SETUPE1  
Enter Setup

---

### Transmit Delay per 12 Characters

**Transmit Delay per 12 Characters** applies to Expanded Febraban only. This feature is available only when USB HID Keyboard is enabled.



@FEBMENO

**\*\* Disable Transmit Delay per 12 Characters**



@FEBMEN1

**Enable Transmit Delay per 12 Characters**

You may select an appropriate delay value from the options below as per your actual needs.



@FEBMDT0

**0ms**



@FEBMDT1

**300ms**



@FEBMDT2

**400ms**



@SETUPE0  
**\*\* Exit Setup**



@SETUPE1  
**Enter Setup**

---



@FEBMDT4  
**600ms**



@FEBMDT3  
**\*\* 500ms**



@FEBMDT5  
**700ms**



@FEBMDT6  
**800ms**



@FEBMDT7  
**900ms**



@SETUPE0  
**\*\* Exit Setup**



@SETUPE1  
Enter Setup

---

## ITF-14

ITF-14 is a special kind of Interleaved 2 of 5 with a length of 14 characters and the last character as the check character.

ITF-14 priority principle: For the Interleaved 2 of 5 barcodes with a length of 14 characters and the last character as the check character, the ITF-14 configurations shall take precedence over the Interleaved 2 of 5 settings.

### Restore Factory Defaults



@I14DEF

Restore the Factory Defaults of ITF-14

### Enable/Disable ITF-14



@I14ENA0

\*\* Disable ITF-14



@I14ENA1

Enable ITF-14 But Do Not Transmit Check Character



@I14ENA2

Enable ITF-14 and Transmit Check Character



An example of the ITF-14 priority principle: when ITF-14 is enabled and Interleaved 2 of 5 is disabled, the scanner only decodes Interleaved 2 of 5 barcodes with a length of 14 characters and the last character as the check character.



@SETUPE0  
\*\* Exit Setup



@SETUPE1  
Enter Setup

## ITF-6

ITF-6 is a special kind of Interleaved 2 of 5 with a length of 6 characters and the last character as the check character.

ITF-6 priority principle: For the Interleaved 2 of 5 barcodes with a length of 6 characters and the last character as the check character, the ITF-6 configurations shall take precedence over the Interleaved 2 of 5 settings.

### Restore Factory Defaults



Restore the Factory Defaults of ITF-6

### Enable/Disable ITF-6



\*\* Disable ITF-6



Enable ITF-6 But Do Not Transmit Check Character



Enable ITF-6 and Transmit Check Character



An example of the ITF-6 priority principle: when ITF-6 is enabled and Interleaved 2 of 5 is disabled, the scanner only decodes Interleaved 2 of 5 barcodes with a length of 6 characters and the last character as the check character.

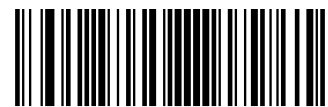

@SETUPE0  
\*\* Exit Setup



@SETUPE1  
Enter Setup

---

## Matrix 2 of 5

### Restore Factory Defaults



@M25DEF

Restore the Factory Defaults of Matrix 2 of 5

### Enable/Disable Matrix 2 of 5



@M25ENA1

\*\* Enable Matrix 2 of 5



@M25ENA0

Disable Matrix 2 of 5



If the scanner fails to identify Matrix 2 of 5 barcodes, you may first try this solution by scanning the **Enter Setup** barcode and then **Enable Matrix 2 of 5** barcode.



@SETUPE0  
\*\* Exit Setup



@SETUPE1  
Enter Setup

## Set Length Range for Matrix 2 of 5

The scanner can be configured to only decode Matrix 2 of 5 barcodes with lengths that fall between (inclusive) the minimum and maximum lengths. To accomplish it, you need to set the minimum and maximum lengths.



@M25MIN

**Set the Minimum Length (Default: 4)**



@M25MAX

**Set the Maximum Length (Default: 80)**



If minimum length is set to be greater than maximum length, the scanner only decodes Matrix 2 of 5 barcodes with either the minimum or maximum length. If minimum length is same as maximum length, only Matrix 2 of 5 barcodes with that length are to be decoded.

## Example

**Set the scanner to decode Matrix 2 of 5 barcodes containing between 8 and 12 characters:**

1. Scan the **Enter Setup** barcode.
2. Scan the **Set the Minimum Length** barcode.
3. Scan the numeric barcode "8" from the "Digit Barcodes" section in Appendix.
4. Scan the **Save** barcode from the "Save/Cancel Barcodes" section in Appendix.
5. Scan the **Set the Maximum Length** barcode.
6. Scan the numeric barcodes "1" and "2" from the "Digit Barcodes" section in Appendix.
7. Scan the **Save** barcode from the "Save/Cancel Barcodes" section in Appendix.
8. Scan the **Exit Setup** barcode.

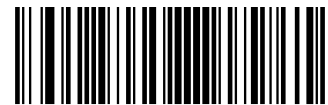

@SETUPE0  
\*\* Exit Setup



@SETUPE1  
Enter Setup

## Check Character Verification

A check character is optional for Matrix 2 of 5 and can be added as the last character. It is a calculated value used to verify the integrity of the data.

- ✧ **Disable:** The scanner transmits Matrix 2 of 5 barcodes as is.
- ✧ **Do Not Transmit Check Character After Verification:** The scanner checks the integrity of all Matrix 2 of 5 barcodes to verify that the data complies with the check character algorithm. Barcodes passing the check will be transmitted except the last digit, whereas those failing it will not be transmitted.
- ✧ **Transmit Check Character After Verification:** The scanner checks the integrity of all Matrix 2 of 5 barcodes to verify that the data complies with the check character algorithm. Barcodes passing the check will be transmitted, whereas those failing it will not be transmitted.

Since Matrix 2 of 5 must always have an even number of digits, a zero may need to be added as the first digit when the check character is added. The check character is automatically generated when making Matrix 2 of 5 barcodes.



@M25CHK0  
**\*\* Disable**



@M25CHK1  
**Do Not Transmit Check Character After Verification**



@M25CHK2  
**Transmit Check Character After Verification**



If the **Do Not Transmit Check Character After Verification** option is enabled, Matrix 2 of 5 barcodes with a length that is less than the configured minimum length after having the check character excluded will not be decoded. (For example, when the **Do Not Transmit Check Character After Verification** option is enabled and the minimum length is set to 4, Matrix 2 of 5 barcodes with a total length of 4 characters including the check character cannot be read.)



@SETUPE0  
**\*\* Exit Setup**





@SETUPE1  
**Enter Setup**

---

## Code 39

### Restore Factory Defaults



@C39DEF  
**Restore the Factory Defaults of Code 39**

### Enable/Disable Code 39



@C39ENA1  
**\*\* Enable Code 39**



@C39ENA0  
**Disable Code 39**



If the scanner fails to identify Code 39 barcodes, you may first try this solution by scanning the **Enter Setup** barcode and then **Enable Code 39** barcode.



@SETUPE0  
**\*\* Exit Setup**



@SETUPE1  
Enter Setup

### Set Length Range for Code 39

The scanner can be configured to only decode Code 39 barcodes with lengths that fall between (inclusive) the minimum and maximum lengths. To accomplish it, you need to set the minimum and maximum lengths.



@C39MIN

Set the Minimum Length (Default: 1)



@C39MAX

Set the Maximum Length (Default: 48)



If minimum length is set to be greater than maximum length, the scanner only decodes Code 39 barcodes with either the minimum or maximum length. If minimum length is same as maximum length, only Code 39 barcodes with that length are to be decoded.



Set the scanner to decode Code 39 barcodes containing between 8 and 12 characters:

1. Scan the **Enter Setup** barcode.
2. Scan the **Set the Minimum Length** barcode.
3. Scan the numeric barcode “8” from the “Digit Barcodes” section in Appendix.
4. Scan the **Save** barcode from the “Save/Cancel Barcodes” section in Appendix.
5. Scan the **Set the Maximum Length** barcode.
6. Scan the numeric barcodes “1” and “2” from the “Digit Barcodes” section in Appendix.
7. Scan the **Save** barcode from the “Save/Cancel Barcodes” section in Appendix.
8. Scan the **Exit Setup** barcode.



@SETUPE0

\*\* Exit Setup



@SETUPE1  
Enter Setup

## Check Character Verification

A check character is optional for Code 39 and can be added as the last character. It is a calculated value used to verify the integrity of the data.

- ✧ **Disable:** The scanner transmits Code 39 barcodes as is.
- ✧ **Do Not Transmit Check Character After Verification:** The scanner checks the integrity of all Code 39 barcodes to verify that the data complies with the check character algorithm. Barcodes passing the check will be transmitted except the last digit, whereas those failing it will not be transmitted.
- ✧ **Transmit Check Character After Verification:** The scanner checks the integrity of all Code 39 barcodes to verify that the data complies with the check character algorithm. Barcodes passing the check will be transmitted, whereas those failing it will not be transmitted.



@C39CHK0  
\*\* Disable



@C39CHK1  
Do Not Transmit Check Character After Verification



@C39CHK2  
Transmit Check Character After Verification



If the **Do Not Transmit Check Character After Verification** option is enabled, Code 39 barcodes with a length that is less than the configured minimum length after having the check character excluded will not be decoded. (For example, when the **Do Not Transmit Check Character After Verification** option is enabled and the minimum length is set to 4, Code 39 barcodes with a total length of 4 characters including the check character cannot be read.)



@SETUPE0  
\*\* Exit Setup



@SETUPE1  
Enter Setup

---

### Transmit Start/Stop Character

Code 39 uses an asterisk (\*) for both the start and the stop characters. You can choose whether or not to transmit the start/stop characters by scanning the appropriate barcode below.



@C39TSC0

**\*\* Do Not Transmit Start/Stop Character**



@C39TSC1

**Transmit Start/Stop Character**

### Enable/Disable Code 39 Full ASCII

The scanner can be configured to identify all ASCII characters by scanning the appropriate barcode below.



@C39ASC0

**\*\* Disable Code 39 Full ASCII**



@C39ASC1

**Enable Code 39 Full ASCII**



@SETUPE0  
**\*\* Exit Setup**



@SETUPE1  
Enter Setup

---

### Enable/Disable Code 32 (Italian Pharma Code)

Code 32 is a variant of Code 39 used by the Italian pharmaceutical industry. Scan the appropriate bar code below to enable or disable Code 32. Code 39 must be enabled and Code 39 check character verification must be disabled for this parameter to function.



@C39E320  
**\*\* Disable Code 32**



@C39E321  
**Enable Code 32**

### Code 32 Prefix

Scan the appropriate barcode below to enable or disable adding the prefix character "A" to all Code 32 barcodes. Code 32 must be enabled for this parameter to function.



@C39S320  
**\*\* Disable Code 32 Prefix**



@C39S321  
**Enable Code 32 Prefix**

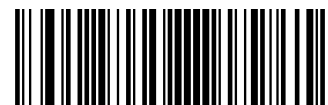

@SETUPE0  
**\*\* Exit Setup**



@SETUPE1  
Enter Setup

---

### Transmit Code 32 Start/Stop Character

Code 32 must be enabled for this parameter to function.



@C39T320

\*\* Do Not Transmit Code 32 Start/Stop Character



@C39T321

Transmit Code 32 Start/Stop Character

### Transmit Code 32 Check Character

Code 32 must be enabled for this parameter to function.



@C39C320

\*\* Do Not Transmit Code 32 Check Character



@C39C321

Transmit Code 32 Check Character



@SETUPE0  
\*\* Exit Setup



@SETUPE1  
**Enter Setup**

---

## Codabar

### Restore Factory Defaults



@CBADEF  
**Restore the Factory Defaults of Codabar**

### Enable/Disable Codabar



@CBAENA1  
**\*\* Enable Codabar**



@CBAENA0  
**Disable Codabar**



If the scanner fails to identify Codabar barcodes, you may first try this solution by scanning the **Enter Setup** barcode and then **Enable Codabar** barcode.



@SETUPE0  
**\*\* Exit Setup**



@SETUPE1  
Enter Setup

## Set Length Range for Codabar

The scanner can be configured to only decode Codabar barcodes with lengths that fall between (inclusive) the minimum and maximum lengths. To accomplish it, you need to set the minimum and maximum lengths.



@CBAMIN

**Set the Minimum Length (Default: 2)**



@CBAMAX

**Set the Maximum Length (Default: 60)**



If minimum length is set to be greater than maximum length, the scanner only decodes Codabar barcodes with either the minimum or maximum length. If minimum length is same as maximum length, only Codabar barcodes with that length are to be decoded.

**E**  
*xample*

**Set the scanner to decode Codabar barcodes containing between 8 and 12 characters:**

1. Scan the **Enter Setup** barcode.
2. Scan the **Set the Minimum Length** barcode.
3. Scan the numeric barcode “8” from the “Digit Barcodes” section in Appendix.
4. Scan the **Save** barcode from the “Save/Cancel Barcodes” section in Appendix.
5. Scan the **Set the Maximum Length** barcode.
6. Scan the numeric barcodes “1” and “2” from the “Digit Barcodes” section in Appendix.
7. Scan the **Save** barcode from the “Save/Cancel Barcodes” section in Appendix.
8. Scan the **Exit Setup** barcode.



@SETUPE0

**\*\* Exit Setup**





@SETUPE1  
Enter Setup

### Check Character Verification

A check character is optional for Codabar and can be added as the last character. It is a calculated value used to verify the integrity of the data.

- ✧ **Disable:** The scanner transmits Codabar barcodes as is.
- ✧ **Do Not Transmit Check Character After Verification:** The scanner checks the integrity of all Codabar barcodes to verify that the data complies with the check character algorithm. Barcodes passing the check will be transmitted except the last digit, whereas those failing it will not be transmitted.
- ✧ **Transmit Check Character After Verification:** The scanner checks the integrity of all Codabar barcodes to verify that the data complies with the check character algorithm. Barcodes passing the check will be transmitted, whereas those failing it will not be transmitted.



@CBACHK0  
**\*\* Disable**

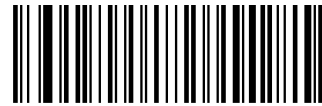

@CBACHK1

**Do Not Transmit Check Character After Verification**



@CBACHK2

**Transmit Check Character After Verification**



If the **Do Not Transmit Check Character After Verification** option is enabled, Codabar barcodes with a length that is less than the configured minimum length after having the check character excluded will not be decoded. (For example, when the **Do Not Transmit Check Character After Verification** option is enabled and the minimum length is set to 4, Codabar barcodes with a total length of 4 characters including the check character cannot be read.)

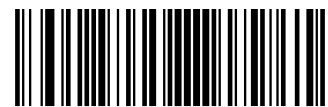

@SETUPE0  
**\*\* Exit Setup**



@SETUPE1  
Enter Setup

---

### Start/Stop Character

You can set the start/stop characters and choose whether or not to transmit the start/stop characters by scanning the appropriate barcode below.



@CBATSC0

**\*\* Do Not Transmit Start/Stop Character**



@CBATSC1

**Transmit Start/Stop Character**



@CBASCF0

**\*\* ABCD/ABCD as the Start/Stop Character**



@CBASCF1

**ABCD/TN\*E as the Start/Stop Character**



@CBASCF2

**abcd/abcd as the Start/Stop Character**



@CBASCF3

**abcd/tn\*e as the Start/Stop Character**



@SETUPE0  
**\*\* Exit Setup**



@SETUPE1  
**Enter Setup**

## Code 93

### Restore Factory Defaults



@C93DEF

**Restore the Factory Defaults of Code 93**

### Enable/Disable Code 93



@C93ENA1

**Enable Code 93**



@C93ENA0

**\*\* Disable Code 93**



If the scanner fails to identify Code 93 barcodes, you may first try this solution by scanning the **Enter Setup** barcode and then **Enable Code 93** barcode.



@SETUPE0  
**\*\* Exit Setup**



@SETUPE1  
Enter Setup

## Set Length Range for Code 93

The scanner can be configured to only decode Code 93 barcodes with lengths that fall between (inclusive) the minimum and maximum lengths. To accomplish it, you need to set the minimum and maximum lengths.



@C93MIN

**Set the Minimum Length (Default: 1)**



@C93MAX

**Set the Maximum Length (Default: 48)**



If minimum length is set to be greater than maximum length, the scanner only decodes Code 93 barcodes with either the minimum or maximum length. If minimum length is same as maximum length, only Code 93 barcodes with that length are to be decoded.

**E**  
*xample*

**Set the scanner to decode Code 93 barcodes containing between 8 and 12 characters:**

1. Scan the **Enter Setup** barcode.
2. Scan the **Set the Minimum Length** barcode.
3. Scan the numeric barcode “8” from the “Digit Barcodes” section in Appendix.
4. Scan the **Save** barcode from the “Save/Cancel Barcodes” section in Appendix.
5. Scan the **Set the Maximum Length** barcode.
6. Scan the numeric barcodes “1” and “2” from the “Digit Barcodes” section in Appendix.
7. Scan the **Save** barcode from the “Save/Cancel Barcodes” section in Appendix.
8. Scan the **Exit Setup** barcode.



@SETUPE0

**\*\* Exit Setup**



@SETUPE1

Enter Setup

### Check Character Verification

Check characters are optional for Code 93 and can be added as the last two characters, which are calculated values used to verify the integrity of the data.

- ✧ **Disable:** The scanner transmits Code 93 barcodes as is.
- ✧ **Do Not Transmit Check Character After Verification:** The scanner checks the integrity of all Code 93 barcodes to verify that the data complies with the check character algorithm. Barcodes passing the checks will be transmitted except the last two digits, whereas those failing them will not be transmitted.
- ✧ **Transmit Check Character After Verification:** The scanner checks the integrity of all Code 93 barcodes to verify that the data complies with the check character algorithm. Barcodes passing the checks will be transmitted, whereas those failing them will not be transmitted.



@C93CHK0

Disable

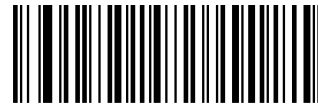

@C93CHK1

**\*\* Do Not Transmit Check Character After Verification**



@C93CHK2

**Transmit Check Character After Verification**



If the **Do Not Transmit Check Character After Verification** option is enabled, Code 93 barcodes with a length that is less than the configured minimum length after having the two check characters excluded will not be decoded. (For example, when the **Do Not Transmit Check Character After Verification** option is enabled and the minimum length is set to 4, Code 93 barcodes with a total length of 4 characters including the two check characters cannot be read.)



@SETUPE0

**\*\* Exit Setup**



@SETUPE1  
Enter Setup

---

## China Post 25

### Restore Factory Defaults



@CHPDEF  
Restore the Factory Defaults of China Post 25

### Enable/Disable China Post 25



@CHPENA1  
Enable China Post 25



@CHPENA0  
**\*\* Disable China Post 25**



If the scanner fails to identify China Post 25 barcodes, you may first try this solution by scanning the **Enter Setup** barcode and then **Enable China Post 25** barcode.



@SETUPE0  
**\*\* Exit Setup**



@SETUPE1  
**Enter Setup**

## Set Length Range for China Post 25

The scanner can be configured to only decode China Post 25 barcodes with lengths that fall between (inclusive) the minimum and maximum lengths. To accomplish it, you need to set the minimum and maximum lengths.



**Set the Minimum Length (Default: 1)**



**Set the Maximum Length (Default: 48)**



If minimum length is set to be greater than maximum length, the scanner only decodes China Post 25 barcodes with either the minimum or maximum length. If minimum length is same as maximum length, only China Post 25 barcodes with that length are to be decoded.



**Set the scanner to decode China Post 25 barcodes containing between 8 and 12 characters:**

1. Scan the **Enter Setup** barcode.
2. Scan the **Set the Minimum Length** barcode.
3. Scan the numeric barcode “8” from the “Digit Barcodes” section in Appendix.
4. Scan the **Save** barcode from the “Save/Cancel Barcodes” section in Appendix.
5. Scan the **Set the Maximum Length** barcode.
6. Scan the numeric barcodes “1” and “2” from the “Digit Barcodes” section in Appendix.
7. Scan the **Save** barcode from the “Save/Cancel Barcodes” section in Appendix.
8. Scan the **Exit Setup** barcode.



@SETUPE0  
**\*\* Exit Setup**



@SETUPE1  
Enter Setup

---

### Check Character Verification

A check character is optional for China Post 25 and can be added as the last character. It is a calculated value used to verify the integrity of the data.

- ✧ **Disable:** The scanner transmits China Post 25 barcodes as is.
- ✧ **Do Not Transmit Check Character After Verification:** The scanner checks the integrity of all China Post 25 barcodes to verify that the data complies with the check character algorithm. Barcodes passing the check will be transmitted except the last digit, whereas those failing it will not be transmitted.
- ✧ **Transmit Check Character After Verification:** The scanner checks the integrity of all China Post 25 barcodes to verify that the data complies with the check character algorithm. Barcodes passing the check will be transmitted, whereas those failing it will not be transmitted.



@CHPCHK0  
**\*\* Disable**

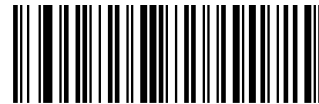

@CHPCHK1

**Do Not Transmit Check Character After Verification**



@CHPCHK2

**Transmit Check Character After Verification**



If the **Do Not Transmit Check Character After Verification** option is enabled, China Post 25 barcodes with a length that is less than the configured minimum length after having the check character excluded will not be decoded. (For example, when the **Do Not Transmit Check Character After Verification** option is enabled and the minimum length is set to 4, China Post 25 barcodes with a total length of 4 characters including the check character cannot be read.)



@SETUPE0  
**\*\* Exit Setup**





@SETUPE1  
**Enter Setup**

---

## GS1-128 (UCC/EAN-128)

### Restore Factory Defaults



@GS1DEF

**Restore the Factory Defaults of GS1-128**

### Enable/Disable GS1-128



@GS1ENA1

**\*\* Enable GS1-128**



@GS1ENA0

**Disable GS1-128**



If the scanner fails to identify GS1-128 barcodes, you may first try this solution by scanning the **EnterSetup** barcode and then **Enable GS1-128** barcode.



@SETUPE0  
**\*\* Exit Setup**



@SETUPE1  
Enter Setup

## Set Length Range for GS1-128

The scanner can be configured to only decode GS1-128 barcodes with lengths that fall between (inclusive) the minimum and maximum lengths. To accomplish it, you need to set the minimum and maximum lengths.



@GS1MIN

Set the Minimum Length (Default: 1)



@GS1MAX

Set the Maximum Length (Default: 48)



If minimum length is set to be greater than maximum length, the scanner only decodes GS1-128 barcodes with either the minimum or maximum length. If minimum length is same as maximum length, only GS1-128 barcodes with that length are to be decoded.



**Set the scanner to decode GS1-128 barcodes containing between 8 and 12 characters:**

1. Scan the **Enter Setup** barcode.
2. Scan the **Set the Minimum Length** barcode.
3. Scan the numeric barcode "8" from the "Digit Barcodes" section in Appendix.
4. Scan the **Save** barcode from the "Save/Cancel Barcodes" section in Appendix.
5. Scan the **Set the Maximum Length** barcode.
6. Scan the numeric barcodes "1" and "2" from the "Digit Barcodes" section in Appendix.
7. Scan the **Save** barcode from the "Save/Cancel Barcodes" section in Appendix.
8. Scan the **Exit Setup** barcode.



@SETUPE0

\*\* Exit Setup



@SETUPE1  
**Enter Setup**

---

## GS1 Databar (RSS)

### Restore Factory Defaults



@RSSDEF  
**Restore the Factory Defaults of GS1 Databar**

### Enable/Disable GS1 Databar



@RSSENA1  
**\*\* Enable GS1 Databar**



@RSSENA0  
**Disable GS1 Databar**



If the scanner fails to identify GS1 Databar barcodes, you may first try this solution by scanning the **Enter Setup** barcode and then **Enable GS1 Databar** barcode.



@SETUPE0  
**\*\* Exit Setup**



@SETUPE1  
Enter Setup

---

**Transmit Application Identifier “01”**



@RSSTAI1

**\*\* Transmit Application Identifier “01”**



@RSSTAI0

**Do Not Transmit Application Identifier “01”**

**GS1 Composite (EAN-UCC Composite)**

**Restore Factory Defaults**



@CPTDEF

**Restore the Factory Defaults of GS1 Composite**

**Enable/Disable GS1 Composite**



@CPTENA1

**Enable GS1 Composite**



@CPTENA0

**\*\* Disable GS1 Composite**



If the scanner fails to identify GS1 Composite barcodes, you may first try this solution by scanning the **Enter Setup** barcode and then **Enable GS1 Composite** barcode.



@SETUPE0

**\*\* Exit Setup**



@SETUPE1  
Enter Setup

---

### Enable/Disable UPC/EAN Composite



@CPTUPC1  
Enable UPC/EAN Composite



@CPTUPC0  
\*\* Disable UPC/EAN Composite

### Code 11

#### Restore Factory Defaults



@C11DEF  
Restore the Factory Defaults of Code 11

#### Enable/Disable Code 11



@C11ENA1  
Enable Code 11



@C11ENA0  
\*\* Disable Code 11



If the scanner fails to identify Code 11 barcodes, you may first try this solution by scanning the **Enter Setup** barcode and then **Enable Code 11** barcode.



@SETUPE0  
\*\* Exit Setup



@SETUPE1  
Enter Setup

## Set Length Range for Code 11

The scanner can be configured to only decode Code 11 barcodes with lengths that fall between (inclusive) the minimum and maximum lengths. To accomplish it, you need to set the minimum and maximum lengths.



@C11MIN

**Set the Minimum Length (Default: 4)**



@C11MAX

**Set the Maximum Length (Default: 48)**



If minimum length is set to be greater than maximum length, the scanner only decodes Code 11 barcodes with either the minimum or maximum length. If minimum length is same as maximum length, only Code 11 barcodes with that length are to be decoded.

**E**  
*xample*

**Set the scanner to decode Code 11 barcodes containing between 8 and 12 characters:**

1. Scan the **Enter Setup** barcode.
2. Scan the **Set the Minimum Length** barcode.
3. Scan the numeric barcode “8” from the “Digit Barcodes” section in Appendix.
4. Scan the **Save** barcode from the “Save/Cancel Barcodes” section in Appendix.
5. Scan the **Set the Maximum Length** barcode.
6. Scan the numeric barcodes “1” and “2” from the “Digit Barcodes” section in Appendix.
7. Scan the **Save** barcode from the “Save/Cancel Barcodes” section in Appendix.
8. Scan the **Exit Setup** barcode.



@SETUPE0

**\*\* Exit Setup**



@SETUPE1  
Enter Setup

### Check Character Verification

Check characters are optional for Code 11 and can be added as the last one or two characters, which are calculated values used to verify the integrity of the data.

If the **Disable** option is enabled, the scanner transmits Code 11 barcodes as is.



@C11CHK0  
Disable



@C11CHK1  
\*\* One Check Character, MOD11



@C11CHK2  
Two Check Characters, MOD11/MOD11



@C11CHK3  
Two Check Characters, MOD11/MOD9



@C11CHK4  
One Check Character, MOD11 (Len<=10)  
Two Check Characters, MOD11/MOD11(Len>10)



@C11CHK5  
One Check Character, MOD11 (Len<=10)  
Two Check Characters, MOD11/MOD9 (Len>10)

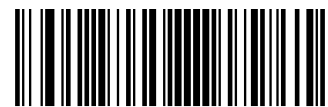

@SETUPE0  
\*\* Exit Setup



@SETUPE1  
Enter Setup

---

### Transmit Check Character



@C11TCK0

**Do Not Transmit Code 11 Check Character**



@C11TCK1

**\*\* Transmit Code 11 Check Character**



If you select a check character algorithm and the **Do Not Transmit Check Character** option, Code 11 barcodes with a length that is less than the configured minimum length after having the check character(s) excluded will not be decoded. (For example, when the **One Check Character, MOD11** and **Do Not Transmit Check Character** options are enabled and the minimum length is set to 4, Code 11 barcodes with a total length of 4 characters including the check character cannot be read.)



@SETUPE0  
**\*\* Exit Setup**





@SETUPE1  
**Enter Setup**

---

## ISBN

### Restore Factory Defaults



@ISBDEF

**Restore the Factory Defaults of ISBN**

### Enable/Disable ISBN



@ISBENA1

**Enable ISBN**



@ISBENA0

**\*\* Disable ISBN**



If the scanner fails to identify ISBN barcodes, you may first try this solution by scanning the **Enter Setup** barcode and then **Enable ISBN** barcode.



@SETUPE0

**\*\* Exit Setup**



@SETUPE1  
**Enter Setup**

---

### Set ISBN Format



@ISBT101  
**\*\* ISBN-10**



@ISBT100  
**ISBN-13**



@SETUPE0  
**\*\* Exit Setup**



@SETUPE1  
**Enter Setup**

---

## ISSN

### Restore Factory Defaults



@ISSDEF  
**Restore the Factory Defaults of ISSN**

### Enable/Disable ISSN



@ISSENA1  
**Enable ISSN**



@ISSENA0  
**\*\* Disable ISSN**



If the scanner fails to identify ISSN barcodes, you may first try this solution by scanning the **Enter Setup** barcode and then **Enable ISSN** barcode.



@SETUPE0  
**\*\* Exit Setup**



@SETUPE1  
Enter Setup

---

## Industrial 25

### Restore Factory Defaults



@L25DEF  
Restore the Factory Defaults of Industrial 25

### Enable/Disable Industrial 25



@L25ENA1  
Enable Industrial 25



@L25ENA0  
**\*\* Disable Industrial 25**



If the scanner fails to identify Industrial 25 barcodes, you may first try this solution by scanning the **Enter Setup** barcode and then **Enable Industrial 25** barcode.



@SETUPE0  
**\*\* Exit Setup**



@SETUPE1  
Enter Setup

## Set Length Range for Industrial 25

The scanner can be configured to only decode Industrial 25 barcodes with lengths that fall between (inclusive) the minimum and maximum lengths. To accomplish it, you need to set the minimum and maximum lengths.



Set the Minimum Length (Default: 6)



Set the Maximum Length (Default: 48)



If minimum length is set to be greater than maximum length, the scanner only decodes Industrial 25 barcodes with either the minimum or maximum length. If minimum length is same as maximum length, only Industrial 25 barcodes with that length are to be decoded.



**Set the scanner to decode Industrial 25 barcodes containing between 8 and 12 characters:**

1. Scan the **Enter Setup** barcode.
2. Scan the **Set the Minimum Length** barcode.
3. Scan the numeric barcode “8” from the “Digit Barcodes” section in Appendix.
4. Scan the **Save** barcode from the “Save/Cancel Barcodes” section in Appendix.
5. Scan the **Set the Maximum Length** barcode.
6. Scan the numeric barcodes “1” and “2” from the “Digit Barcodes” section in Appendix.
7. Scan the **Save** barcode from the “Save/Cancel Barcodes” section in Appendix.
8. Scan the **Exit Setup** barcode.



@SETUPE0  
\*\* Exit Setup



@SETUPE1  
Enter Setup

## Check Character Verification

A check character is optional for Industrial 25 and can be added as the last character. It is a calculated value used to verify the integrity of the data.

- ✧ **Disable:** The scanner transmits Industrial 25 barcodes as is.
- ✧ **Do Not Transmit Check Character After Verification:** The scanner checks the integrity of all Industrial 25 barcodes to verify that the data complies with the check character algorithm. Barcodes passing the check will be transmitted except the last digit, whereas those failing it will not be transmitted.
- ✧ **Transmit Check Character After Verification:** The scanner checks the integrity of all Industrial 25 barcodes to verify that the data complies with the check character algorithm. Barcodes passing the check will be transmitted, whereas those failing it will not be transmitted.



@L25CHK0  
\*\* Disable



**Do Not Transmit Check Character After Verification**



**Transmit Check Character After Verification**



If the **Do Not Transmit Check Character After Verification** option is enabled, Industrial 25 barcodes with a length that is less than the configured minimum length after having the check character excluded will not be decoded. (For example, when the **Do Not Transmit Check Character After Verification** option is enabled and the minimum length is set to 4, Industrial 25 barcodes with a total length of 4 characters including the check character cannot be read.)



@SETUPE0  
\*\* Exit Setup



@SETUPE1  
**Enter Setup**

## Standard 25

### Restore Factory Defaults



@S25DEF

**Restore the Factory Defaults of Standard 25**

### Enable/Disable Standard 25



@S25ENA1

**Enable Standard 25**



@S25ENA0

**\*\* Disable Standard 25**



If the scanner fails to identify Standard 25 barcodes, you may first try this solution by scanning the **Enter Setup** barcode and then **Enable Standard 25** barcode.



@SETUPE0  
**\*\* Exit Setup**



@SETUPE1  
Enter Setup

## Set Length Range for Standard 25

The scanner can be configured to only decode Standard 25 barcodes with lengths that fall between (inclusive) the minimum and maximum lengths. To accomplish it, you need to set the minimum and maximum lengths.



@S25MIN

**Set the Minimum Length (Default: 6)**



@S25MAX

**Set the Maximum Length (Default: 48)**



If minimum length is set to be greater than maximum length, the scanner only decodes Standard 25 barcodes with either the minimum or maximum length. If minimum length is same as maximum length, only Standard 25 barcodes with that length are to be decoded.

**E**  
*xample*

**Set the scanner to decode Standard 25 barcodes containing between 8 and 12 characters:**

1. Scan the **Enter Setup** barcode.
2. Scan the **Set the Minimum Length** barcode.
3. Scan the numeric barcode “8” from the “Digit Barcodes” section in Appendix.
4. Scan the **Save** barcode from the “Save/Cancel Barcodes” section in Appendix.
5. Scan the **Set the Maximum Length** barcode.
6. Scan the numeric barcodes “1” and “2” from the “Digit Barcodes” section in Appendix.
7. Scan the **Save** barcode from the “Save/Cancel Barcodes” section in Appendix.
8. Scan the **Exit Setup** barcode.



@SETUPE0

**\*\* Exit Setup**





@SETUPE1  
Enter Setup

## Check Character Verification

A check character is optional for Standard 25 and can be added as the last character. It is a calculated value used to verify the integrity of the data.

- ✧ **Disable:** The scanner transmits Standard 25 barcodes as is.
- ✧ **Do Not Transmit Check Character After Verification:** The scanner checks the integrity of all Standard 25 barcodes to verify that the data complies with the check character algorithm. Barcodes passing the check will be transmitted except the last digit, whereas those failing it will not be transmitted.
- ✧ **Transmit Check Character After Verification:** The scanner checks the integrity of all Standard 25 barcodes to verify that the data complies with the check character algorithm. Barcodes passing the check will be transmitted, whereas those failing it will not be transmitted.



@S25CHK0  
\*\* Disable

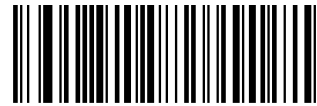

@S25CHK1

**Do Not Transmit Check Character After Verification**



@S25CHK2

**Transmit Check Character After Verification**



If the **Do Not Transmit Check Character After Verification** option is enabled, Standard 25 barcodes with a length that is less than the configured minimum length after having the check character excluded will not be decoded. (For example, when the **Do Not Transmit Check Character After Verification** option is enabled and the minimum length is set to 4, Standard 25 barcodes with a total length of 4 characters including the check character cannot be read.)

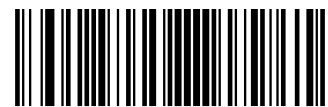

@SETUPE0  
\*\* Exit Setup



@SETUPE1  
**Enter Setup**

---

## Plessey

### Restore Factory Defaults



@PLYDEF  
**Restore the Factory Defaults of Plessey**

### Enable/Disable Plessey



@PLYENA1  
**Enable Plessey**



@PLYENA0  
**\*\* Disable Plessey**



If the scanner fails to identify Plessey barcodes, you may first try this solution by scanning the **Enter Setup** barcode and then **Enable Plessey** barcode.



@SETUPE0  
**\*\* Exit Setup**



@SETUPE1  
**Enter Setup**

## Set Length Range for Plessey

The scanner can be configured to only decode Plessey barcodes with lengths that fall between (inclusive) the minimum and maximum lengths. To accomplish it, you need to set the minimum and maximum lengths.



**Set the Minimum Length (Default: 4)**



**Set the Maximum Length (Default: 48)**



If minimum length is set to be greater than maximum length, the scanner only decodes Plessey barcodes with either the minimum or maximum length. If minimum length is same as maximum length, only Plessey barcodes with that length are to be decoded.



**Set the scanner to decode Plessey barcodes containing between 8 and 12 characters:**

1. Scan the **Enter Setup** barcode.
2. Scan the **Set the Minimum Length** barcode.
3. Scan the numeric barcode “8” from the “Digit Barcodes” section in Appendix.
4. Scan the **Save** barcode from the “Save/Cancel Barcodes” section in Appendix.
5. Scan the **Set the Maximum Length** barcode.
6. Scan the numeric barcodes “1” and “2” from the “Digit Barcodes” section in Appendix.
7. Scan the **Save** barcode from the “Save/Cancel Barcodes” section in Appendix.
8. Scan the **Exit Setup** barcode.



@SETUPE0  
**\*\* Exit Setup**



@SETUPE1  
Enter Setup

---

## Check Character Verification

Check characters are optional for Plessey and can be added as the last two characters, which are calculated values used to verify the integrity of the data.

- ✧ **Disable:** The scanner transmits Plessey barcodes as is.
- ✧ **Do Not Transmit Check Character After Verification:** The scanner checks the integrity of all Plessey barcodes to verify that the data complies with the check character algorithm. Barcodes passing the checks will be transmitted except the last two digits, whereas those failing them will not be transmitted.
- ✧ **Transmit Check Character After Verification:** The scanner checks the integrity of all Plessey barcodes to verify that the data complies with the check character algorithm. Barcodes passing the checks will be transmitted, whereas those failing them will not be transmitted.



@PLYCHK0  
**\*\* Disable**



@PLYCHK1

**Do Not Transmit Check Character After Verification**



@PLYCHK2

**Transmit Check Character After Verification**



If the **Do Not Transmit Check Character After Verification** option is enabled, Plessey barcodes with a length that is less than the configured minimum length after having the check characters excluded will not be decoded. (For example, when the **Do Not Transmit Check Character After Verification** option is enabled and the minimum length is set to 4, Plessey barcodes with a total length of 4 characters including the check characters cannot be read.)



@SETUPE0  
**\*\* Exit Setup**



@SETUPE1  
**Enter Setup**

---

## MSI-Plessey

### Restore Factory Defaults



@MSIDF

**Restore the Factory Defaults of MSI-Plessey**

### Enable/Disable MSI-Plessey

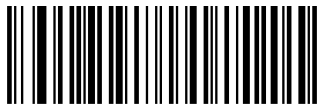

@MSIENA1

**Enable MSI-Plessey**



@MSIENA0

**\*\* Disable MSI-Plessey**



If the scanner fails to identify MSI-Plessey barcodes, you may first try this solution by scanning the **Enter Setup** barcode and then **Enable MSI-Plessey** barcode.



@SETUPE0  
**\*\* Exit Setup**



@SETUPE1  
Enter Setup

## Set Length Range for MSI-Plessey

The scanner can be configured to only decode MSI-Plessey barcodes with lengths that fall between (inclusive) the minimum and maximum lengths. To accomplish it, you need to set the minimum and maximum lengths.



@MSIMIN

**Set the Minimum Length (Default: 4)**



@MSIMAX

**Set the Maximum Length (Default: 48)**



If minimum length is set to be greater than maximum length, the scanner only decodes MSI-Plessey barcodes with either the minimum or maximum length. If minimum length is same as maximum length, only MSI-Plessey barcodes with that length are to be decoded.

**E**  
*xample*

**Set the scanner to decode MSI-Plessey barcodes containing between 8 and 12 characters:**

1. Scan the **Enter Setup** barcode.
2. Scan the **Set the Minimum Length** barcode.
3. Scan the numeric barcode "8" from the "Digit Barcodes" section in Appendix.
4. Scan the **Save** barcode from the "Save/Cancel Barcodes" section in Appendix.
5. Scan the **Set the Maximum Length** barcode.
6. Scan the numeric barcodes "1" and "2" from the "Digit Barcodes" section in Appendix.
7. Scan the **Save** barcode from the "Save/Cancel Barcodes" section in Appendix.
8. Scan the **Exit Setup** barcode.



@SETUPE0

**\*\* Exit Setup**



@SETUPE1  
Enter Setup

### Check Character Verification

Check characters are optional for MSI-Plessey and can be added as the last one or two characters, which are calculated values used to verify the integrity of the data.

If the **Disable** option is enabled, the scanner transmits MSI-Plessey barcodes as is.

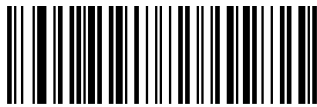

@MSICLK0  
Disable

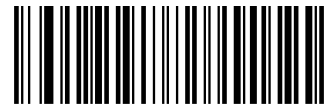

@MSICLK1  
\*\* One Check Character, MOD10



@MSICLK2  
Two Check Characters, MOD10/MOD10

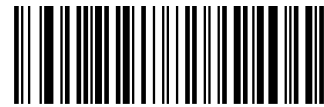

@MSICLK3  
Two Check Characters, MOD10/MOD11



@SETUPE0  
\*\* Exit Setup



@SETUPE1  
Enter Setup

---

### Transmit Check Character



@MSITCK1  
**\*\* Transmit MSI-Plessey Check Character**



@MSITCK0  
**Do Not Transmit MSI-Plessey Check Character**



If you select a check character algorithm and the **Do Not Transmit Check Character** option, MSI-Plessey barcodes with a length that is less than the configured minimum length after having the check character(s) excluded will not be decoded. (For example, when the **One Check Character, MOD10** and **Do Not Transmit Check Character** options are enabled and the minimum length is set to 4, MSI-Plessey barcodes with a total length of 4 characters including the check character cannot be read.)



@SETUPE0  
**\*\* Exit Setup**





@SETUPE1  
**Enter Setup**

---

## AIM 128

### Restore Factory Defaults



@AIMDEF

**Restore the Factory Defaults of AIM 128**

### Enable/Disable AIM 128



@AIMENA1

**Enable AIM 128**



@AIMENA0

**\*\* Disable AIM 128**



If the scanner fails to identify AIM 128 barcodes, you may first try this solution by scanning the **Enter Setup** barcode and then **Enable AIM 128** barcode.



@SETUPE0

**\*\* Exit Setup**



@SETUPE1  
Enter Setup

## Set Length Range for AIM 128

The scanner can be configured to only decode AIM 128 barcodes with lengths that fall between (inclusive) the minimum and maximum lengths. To accomplish it, you need to set the minimum and maximum lengths.



@AIMMIN

**Set the Minimum Length (Default: 1)**



@AIMMAX

**Set the Maximum Length (Default: 48)**



If minimum length is set to be greater than maximum length, the scanner only decodes AIM 128 barcodes with either the minimum or maximum length. If minimum length is same as maximum length, only AIM 128 barcodes with that length are to be decoded.

**E**  
*xample*

**Set the scanner to decode AIM 128 barcodes containing between 8 and 12 characters:**

1. Scan the **Enter Setup** barcode.
2. Scan the **Set the Minimum Length** barcode.
3. Scan the numeric barcode “8” from the “Digit Barcodes” section in Appendix.
4. Scan the **Save** barcode from the “Save/Cancel Barcodes” section in Appendix.
5. Scan the **Set the Maximum Length** barcode.
6. Scan the numeric barcodes “1” and “2” from the “Digit Barcodes” section in Appendix.
7. Scan the **Save** barcode from the “Save/Cancel Barcodes” section in Appendix.
8. Scan the **Exit Setup** barcode.



@SETUPE0

**\*\* Exit Setup**



@SETUPE1  
**Enter Setup**

---

## ISBT 128

### Restore Factory Defaults



@IBTDEF  
**Restore the Factory Defaults of ISBT 128**

### Enable/Disable ISBT 128



@IBTENA1  
**Enable ISBT 128**



@IBTENA0  
**\*\* Disable ISBT 128**



If the scanner fails to identify ISBT 128 barcodes, you may first try this solution by scanning the **Enter Setup** barcode and then **Enable ISBT 128** barcode.



@SETUPE0  
**\*\* Exit Setup**



@SETUPE1  
**Enter Setup**

---

## Code 49

### Restore Factory Defaults



@C49DEF  
**Restore the Factory Defaults of Code 49**

### Enable/Disable Code 49



@C49ENA1  
**Enable Code 49**



@C49ENA0  
**\*\* Disable Code 49**



If the scanner fails to identify Code 49 barcodes, you may first try this solution by scanning the **Enter Setup** barcode and then **Enable Code 49** barcode.



@SETUPE0  
**\*\* Exit Setup**



@SETUPE1  
**Enter Setup**

### Set Length Range for Code 49

The scanner can be configured to only decode Code 49 barcodes with lengths that fall between (inclusive) the minimum and maximum lengths. To accomplish it, you need to set the minimum and maximum lengths.



@C49MIN

**Set the Minimum Length (Default: 1)**



@C49MAX

**Set the Maximum Length (Default: 80)**



If minimum length is set to be greater than maximum length, the scanner only decodes Code 49 barcodes with either the minimum or maximum length. If minimum length is same as maximum length, only Code 49 barcodes with that length are to be decoded.



**Set the scanner to decode Code 49 barcodes containing between 8 and 12 characters:**

1. Scan the **Enter Setup** barcode.
2. Scan the **Set the Minimum Length** barcode.
3. Scan the numeric barcode “8” from the “Digit Barcodes” section in Appendix.
4. Scan the **Save** barcode from the “Save/Cancel Barcodes” section in Appendix.
5. Scan the **Set the Maximum Length** barcode.
6. Scan the numeric barcodes “1” and “2” from the “Digit Barcodes” section in Appendix.
7. Scan the **Save** barcode from the “Save/Cancel Barcodes” section in Appendix.
8. Scan the **Exit Setup** barcode.

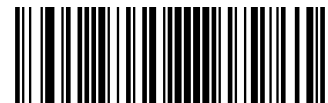

@SETUPE0  
**\*\* Exit Setup**



@SETUPE1  
Enter Setup

---

## Code 16K

### Restore Factory Defaults



@16KDEF  
Restore the Factory Defaults of Code 16K

### Enable/Disable Code 16K



@16KENA1  
Enable Code 16K



@16KENA0  
\*\* Disable Code 16K



If the scanner fails to identify Code 16K barcodes, you may first try this solution by scanning the **Enter Setup** barcode and then **Enable Code 16K** barcode.



@SETUPE0  
\*\* Exit Setup



@SETUPE1  
**Enter Setup**

## Set Length Range for Code 16K

The scanner can be configured to only decode Code 16K barcodes with lengths that fall between (inclusive) the minimum and maximum lengths. To accomplish it, you need to set the minimum and maximum lengths.



@16KMIN

**Set the Minimum Length (Default: 1)**



@16KMAX

**Set the Maximum Length (Default: 80)**



If minimum length is set to be greater than maximum length, the scanner only decodes Code 16K barcodes with either the minimum or maximum length. If minimum length is same as maximum length, only Code 16K barcodes with that length are to be decoded.



**Set the scanner to decode Code 16K barcodes containing between 8 and 12 characters:**

1. Scan the **Enter Setup** barcode.
2. Scan the **Set the Minimum Length** barcode.
3. Scan the numeric barcode “8” from the “Digit Barcodes” section in Appendix.
4. Scan the **Save** barcode from the “Save/Cancel Barcodes” section in Appendix.
5. Scan the **Set the Maximum Length** barcode.
6. Scan the numeric barcodes “1” and “2” from the “Digit Barcodes” section in Appendix.
7. Scan the **Save** barcode from the “Save/Cancel Barcodes” section in Appendix.
8. Scan the **Exit Setup** barcode.



@SETUPE0  
**\*\* Exit Setup**



@SETUPE1  
Enter Setup

---

## COOP 25

### Restore Factory Defaults



@COPDEF  
Restore the Factory Defaults of COOP 25

### Enable/Disable COOP 25



@COPENA1  
Enable COOP 25



@COPENA0  
\*\* Disable COOP 25



If the engine fails to identify COOP 25 barcodes, you may first try this solution by scanning the **Enter Setup** barcode and then **Enable COOP 25** barcode.



@SETUPE0  
\*\* Exit Setup





@SETUPE1  
**Enter Setup**

## Set Length Range for Code 16K

The engine can be configured to only decode COOP 25 barcodes with lengths that fall between (inclusive) the minimum and maximum lengths. To accomplish it, you need to set the minimum and maximum lengths.



@COPMIN

**Set the Minimum Length (Default: 4)**



@COPMAX

**Set the Maximum Length (Default: 80)**



If minimum length is set to be greater than maximum length, the engine only decodes COOP 25 barcodes with either the minimum or maximum length. If minimum length is same as maximum length, only COOP 25 barcodes with that length are to be decoded.



**Set the engine to decode COOP 25 barcodes containing between 8 and 12 characters:**

1. Scan the **Enter Setup** barcode.
2. Scan the **Set the Minimum Length** barcode.
3. Scan the numeric barcode “8” from the “Digit Barcodes” section in Appendix.
4. Scan the **Save** barcode from the “Save/Cancel Barcodes” section in Appendix.
5. Scan the **Set the Maximum Length** barcode.
6. Scan the numeric barcodes “1” and “2” from the “Digit Barcodes” section in Appendix.
7. Scan the **Save** barcode from the “Save/Cancel Barcodes” section in Appendix.
8. Scan the **Exit Setup** barcode.

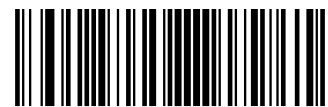

@SETUPE0  
**\*\* Exit Setup**



@SETUPE1  
Enter Setup

---

### Check Character Verification



@COPCHK0  
\*\* Disable



@COPCHK1  
Do Not Transmit Check Character After Verification



@COPCHK2  
Transmit Check Character After Verification



@SETUPE0  
\*\* Exit Setup



@SETUPE1  
**Enter Setup**

---

## PDF417

### Restore Factory Defaults



@PDFDEF  
**Restore the Factory Defaults of PDF417**

### Enable/Disable PDF417



@PDFENA1  
**\*\* Enable PDF417**



@PDFENA0  
**Disable PDF417**



If the scanner fails to identify PDF417 barcodes, you may first try this solution by scanning the **Enter Setup** barcode and then **Enable PDF417** barcode.



@SETUPE0  
**\*\* Exit Setup**



@SETUPE1  
Enter Setup

## Set Length Range for PDF417

The scanner can be configured to only decode PDF417 barcodes with lengths that fall between (inclusive) the minimum and maximum lengths. To accomplish it, you need to set the minimum and maximum lengths.



@PDFMIN

Set the Minimum Length (Default: 1)



@PDFMAX

Set the Maximum Length (Default: 2710)



Minimum length is not allowed to be greater than maximum length. If you only want to read PDF417 barcodes with a specific length, set both minimum and maximum lengths to be that desired length.

**E**  
*xample*

Set the scanner to decode PDF417 barcodes containing between 8 and 12 characters:

1. Scan the **Enter Setup** barcode.
2. Scan the **Set the Minimum Length** barcode.
3. Scan the numeric barcode "8" from the "Digit Barcodes" section in Appendix.
4. Scan the **Save** barcode from the "Save/Cancel Barcodes" section in Appendix.
5. Scan the **Set the Maximum Length** barcode.
6. Scan the numeric barcodes "1" and "2" from the "Digit Barcodes" section in Appendix.
7. Scan the **Save** barcode from the "Save/Cancel Barcodes" section in Appendix.
8. Scan the **Exit Setup** barcode.



@SETUPE0

\*\* Exit Setup



@SETUPE1  
**Enter Setup**

---

## PDF417 Twin Code

PDF417 twin code is 2 PDF417 barcodes paralleled vertically or horizontally. They must both be either regular or inverse barcodes. They must have similar specifications and be placed closely together.

There are 3 options for reading PDF417 twin codes:

- ◇ **Single PDF417 Only:** Read either PDF417 code.
- ◇ **Twin PDF417 Only:** Read both PDF417 codes.
- ◇ **Both Single & Twin:** Read both PDF417 codes. If successful, transmit as twin PDF417 only. Otherwise, try single PDF417 only.



@PDFDOU0  
**\*\* Single PDF417 Only**



@PDFDOU1  
**Twin PDF417 Only**



@PDFDOU2  
**Both Single & Twin**



@SETUPE0  
**\*\* Exit Setup**



@SETUPE1  
Enter Setup

---

### PDF417 Inverse

Regular barcode: Dark bars on a bright background.

Inverse barcode: Bright bars on a dark background.



@PDFINV0

**\*\* Decode Regular PDF417 Barcodes Only**



@PDFINV1

**Decode Inverse PDF417 Barcodes Only**



@PDFINV2

**Decode Both**

### Character Encoding



@PDFENC0

**\*\* Default Character Encoding**



@PDFENC1

**UTF-8**



@PDFENC2

**Automatically Select UTF-8 or Code Page**

---



@SETUPE0

**\*\* Exit Setup**



@SETUPE1  
**Enter Setup**

---

## PDF417 ECI Output



@PDFECI0  
**Disable PDF417 ECI Output**



@PDFECI1  
**\*\* Enable PDF417 ECI Output**



@SETUPE0  
**\*\* Exit Setup**



@SETUPE1  
Enter Setup

---

## Micro PDF417

### Restore Factory Defaults



@MPDDEF  
Restore the Factory Defaults of Micro PDF417

### Enable/Disable Micro PDF417



@MPDENA1  
Enable Micro PDF417



@MPDENA0  
\*\* Disable Micro PDF417



If the scanner fails to identify Micro PDF417 barcodes, you may first try this solution by scanning the **Enter Setup** barcode and then **Enable Micro PDF417** barcode.



@SETUPE0  
\*\* Exit Setup





@SETUPE1  
**Enter Setup**

## Set Length Range for Micro PDF417

The scanner can be configured to only decode Micro PDF417 barcodes with lengths that fall between (inclusive) the minimum and maximum lengths. To accomplish it, you need to set the minimum and maximum lengths.



**Set the Minimum Length (Default: 1)**



**Set the Maximum Length (Default: 366)**



Minimum length is not allowed to be greater than maximum length. If you only want to read Micro PDF417 barcodes with a specific length, set both minimum and maximum lengths to be that desired length.

**E**  
*sample*

**Set the scanner to decode Micro PDF417 barcodes containing between 8 and 12 characters:**

1. Scan the **Enter Setup** barcode.
2. Scan the **Set the Minimum Length** barcode.
3. Scan the numeric barcode “8” from the “Digit Barcodes” section in Appendix.
4. Scan the **Save** barcode from the “Save/Cancel Barcodes” section in Appendix.
5. Scan the **Set the Maximum Length** barcode.
6. Scan the numeric barcodes “1” and “2” from the “Digit Barcodes” section in Appendix.
7. Scan the **Save** barcode from the “Save/Cancel Barcodes” section in Appendix.
8. Scan the **Exit Setup** barcode.



@SETUPE0  
**\*\* Exit Setup**



@SETUPE1  
**Enter Setup**

---

## QR Code

### Restore Factory Defaults



@QRCDEF  
**Restore the Factory Defaults of QR Code**

### Enable/Disable QR Code



@QRCENA1  
**\*\* Enable QR Code**



@QRCENA0  
**Disable QR Code**



If the scanner fails to identify QR Code barcodes, you may first try this solution by scanning the **Enter Setup** barcode and then **Enable QR Code** barcode.



@SETUPE0  
**\*\* Exit Setup**



@SETUPE1  
**Enter Setup**

## Set Length Range for QR Code

The scanner can be configured to only decode QR Code barcodes with lengths that fall between (inclusive) the minimum and maximum lengths. To accomplish it, you need to set the minimum and maximum lengths.



@QRCMIN

**Set the Minimum Length (Default: 1)**



@QRMAX

**Set the Maximum Length (Default: 7089)**



Minimum length is not allowed to be greater than maximum length. If you only want to read QR Code barcodes with a specific length, set both minimum and maximum lengths to be that desired length.

**E**  
*example*

**Set the scanner to decode QR Code barcodes containing between 8 and 12 characters:**

1. Scan the **Enter Setup** barcode.
2. Scan the **Set the Minimum Length** barcode.
3. Scan the numeric barcode "8" from the "Digit Barcodes" section in Appendix.
4. Scan the **Save** barcode from the "Save/Cancel Barcodes" section in Appendix.
5. Scan the **Set the Maximum Length** barcode.
6. Scan the numeric barcodes "1" and "2" from the "Digit Barcodes" section in Appendix.
7. Scan the **Save** barcode from the "Save/Cancel Barcodes" section in Appendix.
8. Scan the **Exit Setup** barcode.



@SETUPE0  
**\*\* Exit Setup**



@SETUPE1  
Enter Setup

---

## QR Twin Code

QR twin code is 2 QR barcodes paralleled vertically or horizontally. They must both be either regular or inverse barcodes. They must have similar specifications and be placed closely together.

There are 3 options for reading QR twin codes:

- ◇ **Single QR Only:** Read either QR code.
- ◇ **Twin QR Only:** Read both QR codes. Transmission sequence: left (upper) QR code followed by right (lower) QR code.
- ◇ **Both Single & Twin:** Read both QR codes. If successful, transmit as twin QR only. Otherwise, try single QR only.



@QRCDU0  
**\*\* Single QR Only**



@QRCDU1  
**Twin QR Only**



@QRCDU2  
**Both Single & Twin**



@SETUPE0  
**\*\* Exit Setup**



@SETUPE1  
Enter Setup

### QR Inverse

Regular barcode: Dark bars on a bright background.

Inverse barcode: Bright bars on a dark background.



@QRCINV0

**\*\* Decode Regular QR Barcodes Only**



@QRCINV1

**Decode Inverse QR Barcodes Only**

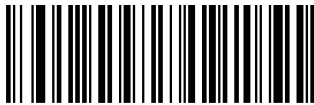

@QRCINV2

**Decode Both**

### Character Encoding



@QRCENC0

**\*\* Default Character Encoding**



@QRCENC1

**UTF-8**



@QRCENC3

**Automatically Select UTF-8 or Code Page**



@SETUPE0

**\*\* Exit Setup**



@SETUPE1

**Enter Setup**

---

**QR ECI Output**



@QRCEC10

**Disable QR ECI Output**



@QRCEC11

**\*\* Enable QR ECI Output**



@SETUPE0

**\*\* Exit Setup**



@SETUPE1  
**Enter Setup**

---

## Micro QR Code

### Restore Factory Defaults



@MQRDEF

**Restore the Factory Defaults of Micro QR**

### Enable/Disable Micro QR



@MQRENA1

**\*\* Enable Micro QR**



@MQRENA0

**Disable Micro QR**



If the scanner fails to identify Micro QR barcodes, you may first try this solution by scanning the **Enter Setup** barcode and then **Enable Micro QR** barcode.



@SETUPE0  
**\*\* Exit Setup**



@SETUPE1  
Enter Setup

## Set Length Range for Micro QR

The scanner can be configured to only decode Micro QR barcodes with lengths that fall between (inclusive) the minimum and maximum lengths. To accomplish it, you need to set the minimum and maximum lengths.



Set the Minimum Length (Default: 1)



Set the Maximum Length (Default: 35)



Minimum length is not allowed to be greater than maximum length. If you only want to read Micro QR barcodes with a specific length, set both minimum and maximum lengths to be that desired length.

**E**  
*xample*

Set the scanner to decode Micro QR Code barcodes containing between 8 and 12 characters:

1. Scan the **Enter Setup** barcode.
2. Scan the **Set the Minimum Length** barcode.
3. Scan the numeric barcode “8” from the “Digit Barcodes” section in Appendix.
4. Scan the **Save** barcode from the “Save/Cancel Barcodes” section in Appendix.
5. Scan the **Set the Maximum Length** barcode.
6. Scan the numeric barcodes “1” and “2” from the “Digit Barcodes” section in Appendix.
7. Scan the **Save** barcode from the “Save/Cancel Barcodes” section in Appendix.
8. Scan the **Exit Setup** barcode.



@SETUPE0  
\*\* Exit Setup





@SETUPE1  
**Enter Setup**

## Aztec

### Restore Factory Defaults



@AZTDEF

**Restore the Factory Defaults of Aztec Code**

### Enable/Disable Aztec Code

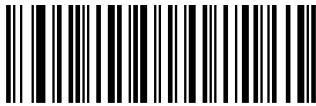

@AZTENA1

**Enable Aztec Code**



@AZTENA0

**\*\* Disable Aztec Code**



If the scanner fails to identify Aztec Code barcodes, you may first try this solution by scanning the **Enter Setup** barcode and then **Enable Aztec Code** barcode.



@SETUPE0  
**\*\* Exit Setup**



@SETUPE1  
Enter Setup

## Set Length Range for Aztec Code

The scanner can be configured to only decode Aztec barcodes with lengths that fall between (inclusive) the minimum and maximum lengths. To accomplish it, you need to set the minimum and maximum lengths.



@AZTMIN

Set the Minimum Length (Default: 1)



@AZTMAX

Set the Maximum Length (Default: 3832)



Minimum length is not allowed to be greater than maximum length. If you only want to read Aztec barcodes with a specific length, set both minimum and maximum lengths to be that desired length.

**E**  
*xample*

**Set the scanner to decode Aztec barcodes containing between 8 and 12 characters:**

1. Scan the **Enter Setup** barcode.
2. Scan the **Set the Minimum Length** barcode.
3. Scan the numeric barcode "8" from the "Digit Barcodes" section in Appendix.
4. Scan the **Save** barcode from the "Save/Cancel Barcodes" section in Appendix.
5. Scan the **Set the Maximum Length** barcode.
6. Scan the numeric barcodes "1" and "2" from the "Digit Barcodes" section in Appendix.
7. Scan the **Save** barcode from the "Save/Cancel Barcodes" section in Appendix.
8. Scan the **Exit Setup** barcode.



@SETUPE0

\*\* Exit Setup



@SETUPE1  
Enter Setup

---

## Read Multi-barcodes on an Image

There are three options:

- ◇ **Mode 1:** Read one barcode only.
- ◇ **Mode 2:** Read fixed number of barcodes only.
- ◇ **Mode 3:** Composite Reading. Read fixed number of barcodes first. If unsuccessful, read one barcode only.



@AZTMOD1  
**\*\* Mode 1**



@AZTMOD2  
**Mode 2**

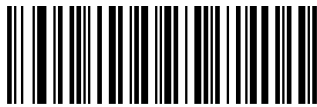

@AZTMOD3  
**Mode 3**

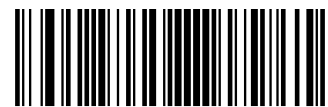

@SETUPE0  
**\*\* Exit Setup**



@SETUPE1  
Enter Setup

---

### Set the Number of Barcodes



@AZTMUL1  
\*\* 1

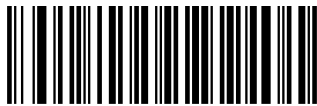

@AZTMUL3  
3

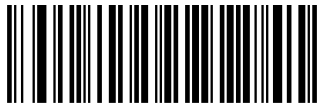

@AZTMUL5  
5

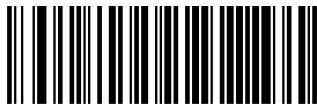

@AZTMUL7  
7



@AZTMUL2  
2



@AZTMUL4  
4

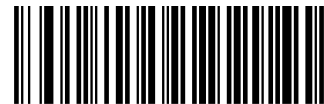

@AZTMUL6  
6



@AZTMUL8  
8



@SETUPE0  
\*\* Exit Setup



@SETUPE1  
Enter Setup

---

## Character Encoding



@AZTENC0

\*\* Default Character Encoding



@AZTENC1

UTF-8

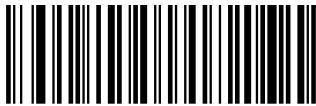

@AZTENC2

Automatically Select UTF-8 or Code Page

## Aztec ECI Output



@AZTECI0

Disable Aztec ECI Output



@AZTECI1

\*\* Enable Aztec ECI Output



@SETUPE0  
\*\* Exit Setup



@SETUPE1  
Enter Setup

---

## Data Matrix

### Restore Factory Defaults



@DMCDEF  
Restore the Factory Defaults of Data Matrix

### Enable/Disable Data Matrix



@DMCENA1  
\*\* Enable Data Matrix



@DMCENA0  
Disable Data Matrix



If the scanner fails to identify Data Matrix barcodes, you may first try this solution by scanning the **Enter Setup** barcode and then **Enable Data Matrix** barcode.



@SETUPE0  
\*\* Exit Setup



@SETUPE1  
**Enter Setup**

### Set Length Range for Data Matrix

The scanner can be configured to only decode Data Matrix barcodes with lengths that fall between (inclusive) the minimum and maximum lengths. To accomplish it, you need to set the minimum and maximum lengths.



**Set the Minimum Length (Default: 1)**



**Set the Maximum Length (Default: 3116)**



Minimum length is not allowed to be greater than maximum length. If you only want to read Data Matrix barcodes with a specific length, set both minimum and maximum lengths to be that desired length.



**Set the scanner to decode Data Matrix barcodes containing between 8 and 12 characters:**

1. Scan the **Enter Setup** barcode.
2. Scan the **Set the Minimum Length** barcode.
3. Scan the numeric barcode “8” from the “Digit Barcodes” section in Appendix.
4. Scan the **Save** barcode from the “Save/Cancel Barcodes” section in Appendix.
5. Scan the **Set the Maximum Length** barcode.
6. Scan the numeric barcodes “1” and “2” from the “Digit Barcodes” section in Appendix.
7. Scan the **Save** barcode from the “Save/Cancel Barcodes” section in Appendix.
8. Scan the **Exit Setup** barcode.

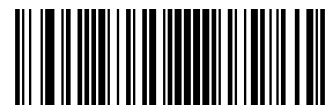

@SETUPE0  
**\*\* Exit Setup**



@SETUPE1  
Enter Setup

---

## Data Matrix Twin Code

Data Matrix twin code is 2 Data Matrix barcodes paralleled vertically or horizontally. They must both be either regular or inverse barcodes. They must have similar specifications and be placed closely together.

There are 3 options for reading Data Matrix twin codes:

- ✧ **Single Data Matrix Only:** Read either Data Matrix code.
- ✧ **Twin Data Matrix Only:** Read both Data Matrix codes. Transmission sequence: left (upper) Data Matrix code followed by right (lower) Data Matrix code.
- ✧ **Both Single & Twin:** Read both Data Matrix codes. If successful, transmit as twin Data Matrix only. Otherwise, try single Data Matrix only.



@DMCDOU0

**\*\* Single Data Matrix Only**



@DMCDOU1

**Twin Data Matrix Only**



@DMCDOU2

**Both Single & Twin**



@SETUPE0  
**\*\* Exit Setup**





@SETUPE1

Enter Setup

### Rectangular Barcode

Data Matrix has two formats:

Square barcodes having the same amount of modules in length and width: 10\*10, 12\*12.... 144\*144.

Rectangular barcodes having different amounts of models in length and width: 6\*16, 6\*14...14\*22.



@DMCREC1

**\*\* Enable Rectangular Barcode**



@DMCREC0

**Disable Rectangular Barcode**

### Data Matrix Inverse

Regular barcode: Dark bars on a bright background.

Inverse barcode: Bright bars on a dark background.



@DMCINV0

**\*\* Decode Regular Data Matrix Barcodes Only**



@DMCINV1

**Decode Inverse Data Matrix Barcodes Only**



@DMCINV2

**Decode Both**



@SETUPE0

**\*\* Exit Setup**



@SETUPE1  
Enter Setup

---

## Character Encoding



@DMCENC0  
\*\* Default Character Encoding



@DMCENC1  
UTF-8



@DMCENC2  
Automatically Select UTF-8 or Code Page

## Data Matrix ECI Output



@DMCEC10  
Disable Data Matrix ECI Output



@DMCEC11  
\*\* Enable Data Matrix ECI Output



@SETUPE0  
\*\* Exit Setup



@SETUPE1  
**Enter Setup**

## Maxicode

### Restore Factory Defaults



@MXCDEF

**Restore the Factory Defaults of Maxicode**

### Enable/Disable Maxicode



@MXCENA1

**Enable Maxicode**



@MXCENA0

**\*\* Disable Maxicode**



If the scanner fails to identify Maxicode barcodes, you may first try this solution by scanning the **Enter Setup** barcode and then **Enable Maxicode** barcode.

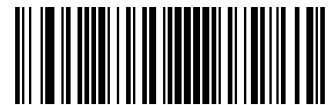

@SETUPE0  
**\*\* Exit Setup**



@SETUPE1  
Enter Setup

## Set Length Range for Maxicode

The scanner can be configured to only decode Maxicode barcodes with lengths that fall between (inclusive) the minimum and maximum lengths. To accomplish it, you need to set the minimum and maximum lengths.



@MXCMIN

Set the Minimum Length (Default: 1)

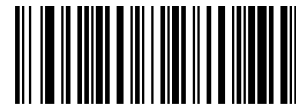

@MXCMAX

Set the Maximum Length (Default:150)



Minimum length is not allowed to be greater than maximum length. If you only want to read Maxicode barcodes with a specific length, set both minimum and maximum lengths to be that desired length.



Set the scanner to decode Maxicode barcodes containing between 8 and 12 characters:

1. Scan the **Enter Setup** barcode.
2. Scan the **Set the Minimum Length** barcode.
3. Scan the numeric barcode "8" from the "Digit Barcodes" section in Appendix.
4. Scan the **Save** barcode from the "Save/Cancel Barcodes" section in Appendix.
5. Scan the **Set the Maximum Length** barcode.
6. Scan the numeric barcodes "1" and "2" from the "Digit Barcodes" section in Appendix.
7. Scan the **Save** barcode from the "Save/Cancel Barcodes" section in Appendix.
8. Scan the **Exit Setup** barcode.



@SETUPE0

\*\* Exit Setup



@SETUPE1  
**Enter Setup**

---

## Chinese Sensible Code

### Restore Factory Defaults



@CSCDEF

**Restore the Factory Defaults of Chinese Sensible Code**

### Enable/Disable Chinese Sensible Code



@CSCENA1

**Enable Chinese Sensible Code**



@CSCENA0

**\*\* Disable Chinese Sensible Code**



If the scanner fails to identify Chinese Sensible Code barcodes, you may first try this solution by scanning the **Enter Setup** barcode and then **Enable Chinese Sensible Code** barcode.



@SETUPE0  
**\*\* Exit Setup**



@SETUPE1  
Enter Setup

## Set Length Range for Chinese Sensible Code

The scanner can be configured to only decode Chinese Sensible Code barcodes with lengths that fall between (inclusive) the minimum and maximum lengths. To accomplish it, you need to set the minimum and maximum lengths.



@CSCMIN

**Set the Minimum Length (Default: 1)**



@CSCMAX

**Set the Maximum Length (Default: 7827)**



Minimum length is not allowed to be greater than maximum length. If you only want to read Chinese Sensible Code barcodes with a specific length, set both minimum and maximum lengths to be that desired length.

**E**  
*xample*

**Set the scanner to decode Chinese Sensible Code barcodes containing between 8 and 12 characters:**

1. Scan the **Enter Setup** barcode.
2. Scan the **Set the Minimum Length** barcode.
3. Scan the numeric barcode “8” from the “Digit Barcodes” section in Appendix.
4. Scan the **Save** barcode from the “Save/Cancel Barcodes” section in Appendix.
5. Scan the **Set the Maximum Length** barcode.
6. Scan the numeric barcodes “1” and “2” from the “Digit Barcodes” section in Appendix.
7. Scan the **Save** barcode from the “Save/Cancel Barcodes” section in Appendix.
8. Scan the **Exit Setup** barcode.



@SETUPE0

**\*\* Exit Setup**



@SETUPE1  
Enter Setup

### Chinese Sensible Twin Code

Chinese Sensible twin code is 2 Chinese Sensible barcodes paralleled vertically or horizontally. They must both be either regular or inverse barcodes. They must have similar specifications and be placed closely together.

There are 3 options for reading Chinese Sensible twin codes:

- ✧ **Single Chinese Sensible Code Only:** Read either Chinese Sensible code.
- ✧ **Twin Chinese Sensible Code Only:** Read both Chinese Sensible codes. Transmission sequence: left (upper) Chinese Sensible code followed by right (lower) Chinese Sensible code.
- ✧ **Both Single & Twin:** Read both Chinese Sensible codes. If successful, transmit as twin Chinese Sensible Code only. Otherwise, try single Chinese Sensible Code only.



**\*\* Single Chinese Sensible Code Only**



**Twin Chinese Sensible Code Only**



**Both Single & Twin**



@SETUPE0  
**\*\* Exit Setup**



@SETUPE1  
**Enter Setup**

---

### **Chinese Sensible Code Inverse**

Regular barcode: Dark bars on a bright background.

Inverse barcode: Bright bars on a dark background.



@CSCINV0

**\*\* Decode Regular Chinese Sensible Barcodes Only**



@CSCINV1

**Decode Inverse Chinese Sensible Barcodes Only**

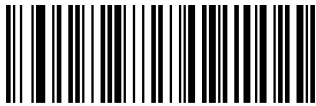

@CSCINV2

**Decode Both**



@SETUPE0  
**\*\* Exit Setup**





@SETUPE1  
**Enter Setup**

---

## GM Code

### Restore Factory Defaults



@GMCDEF  
**Restore the Factory Defaults of GM**

### Enable/Disable GM



@GMCENA1  
**Enable GM**



@GMCENA0  
**\*\* Disable GM**



If the scanner fails to identify GM barcodes, you may first try this solution by scanning the **Enter Setup** barcode and then **Enable GM** barcode.



@SETUPE0  
**\*\* Exit Setup**



@SETUPE1  
Enter Setup

## Set Length Range for GM

The scanner can be configured to only decode GM barcodes with lengths that fall between (inclusive) the minimum and maximum lengths. To accomplish it, you need to set the minimum and maximum lengths.



@GMCMIN

Set the Minimum Length (Default: 1)

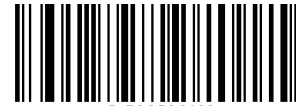

@GMC MAX

Set the Maximum Length (Default: 2751)



Minimum length is not allowed to be greater than maximum length. If you only want to read GM barcodes with a specific length, set both minimum and maximum lengths to be that desired length.



Set the scanner to decode GM barcodes containing between 8 and 12 characters:

1. Scan the **Enter Setup** barcode.
2. Scan the **Set the Minimum Length** barcode.
3. Scan the numeric barcode “8” from the “Digit Barcodes” section in Appendix.
4. Scan the **Save** barcode from the “Save/Cancel Barcodes” section in Appendix.
5. Scan the **Set the Maximum Length** barcode.
6. Scan the numeric barcodes “1” and “2” from the “Digit Barcodes” section in Appendix.
7. Scan the **Save** barcode from the “Save/Cancel Barcodes” section in Appendix.
8. Scan the **Exit Setup** barcode.



@SETUPE0

\*\* Exit Setup



@SETUPE1  
**Enter Setup**

---

## Code One

### Restore Factory Defaults



@ONEDEF

**Restore the Factory Defaults of Code One**

### Enable/Disable Code One



@ONEENA1

**Enable Code One**



@ONEENA0

**\*\* Disable Code One**



If the scanner fails to identify Code One barcodes, you may first try this solution by scanning the **Enter Setup** barcode and then **Enable Code One** barcode.



@SETUPE0

**\*\* Exit Setup**



@SETUPE1  
Enter Setup

## Set Length Range for Code One

The scanner can be configured to only decode Code One barcodes with lengths that fall between (inclusive) the minimum and maximum lengths. To accomplish it, you need to set the minimum and maximum lengths.



@ONEMIN

Set the Minimum Length (Default: 1)



@ONEMAX

Set the Maximum Length (Default: 3550)



Minimum length is not allowed to be greater than maximum length. If you only want to read Code One barcodes with a specific length, set both minimum and maximum lengths to be that desired length.



Set the scanner to decode Code One barcodes containing between 8 and 12 characters:

1. Scan the **Enter Setup** barcode.
2. Scan the **Set the Minimum Length** barcode.
3. Scan the numeric barcode “8” from the “Digit Barcodes” section in Appendix.
4. Scan the **Save** barcode from the “Save/Cancel Barcodes” section in Appendix.
5. Scan the **Set the Maximum Length** barcode.
6. Scan the numeric barcodes “1” and “2” from the “Digit Barcodes” section in Appendix.
7. Scan the **Save** barcode from the “Save/Cancel Barcodes” section in Appendix.
8. Scan the **Exit Setup** barcode.



@SETUPE0

\*\* Exit Setup



@SETUPE1  
Enter Setup

## USPS Postnet

### Restore Factory Defaults



@PNTDEF  
Restore the Factory Defaults of USPS Postnet

### Enable/Disable USPS Postnet



@PNTENA1  
Enable USPS Postnet



@PNTENA0  
\*\* Disable USPS Postnet



If the scanner fails to identify USPS Postnet barcodes, you may first try this solution by scanning the **Enter Setup** barcode and then **Enable USPS Postnet** barcode.

### Transmit Check Character



@PNTCHK1  
Do Not Transmit USPS Postnet Check Character

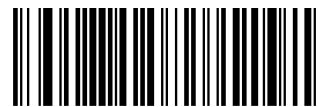

@PNTCHK2  
\*\* Transmit USPS Postnet Check Character

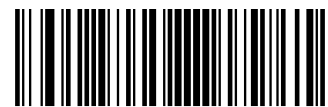

@SETUPE0  
\*\* Exit Setup



@SETUPE1  
Enter Setup

---

## USPS Intelligent Mail

### Restore Factory Defaults



@ILGDEF  
Restore the Factory Defaults of USPS Intelligent Mail

### Enable/Disable USPS Intelligent Mail



@ILGENA1  
Enable USPS Intelligent Mail



@ILGENA0  
**\*\* Disable USPS Intelligent Mail**



If the scanner fails to identify USPS Intelligent Mail barcodes, you may first try this solution by scanning the **Enter Setup** barcode and then **Enable USPS Intelligent Mail** barcode.



@SETUPE0  
**\*\* Exit Setup**



@SETUPE1  
**Enter Setup**

---

## Royal Mail

### Restore Factory Defaults



@ROYDEF  
**Restore the Factory Defaults of Royal Mail**

### Enable/Disable Royal Mail



@ROYENA1  
**Enable Royal Mail**



@ROYENA0  
**\*\* Disable Royal Mail**



If the scanner fails to identify Royal Mail barcodes, you may first try this solution by scanning the **Enter Setup** barcode and then **Enable Royal Mail** barcode.



@SETUPE0  
**\*\* Exit Setup**



@SETUPE1  
Enter Setup

## USPS Planet

### Restore Factory Defaults



@PLADEF  
Restore the Factory Defaults of USPS Planet

### Enable/Disable USPS Planet



@PLAENA1  
Enable USPS Planet



@PLAENA0  
\*\* Disable USPS Planet



If the scanner fails to identify USPS Planet barcodes, you may first try this solution by scanning the **Enter Setup** barcode and then **Enable USPS Planet** barcode.

### Transmit Check Character

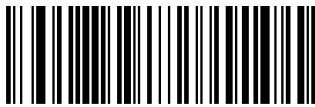

@PLACHK1  
Do Not Transmit USPS Planet Check Character

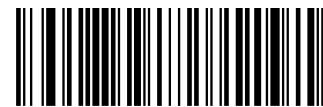

@PLACHK2  
\*\* Transmit USPS Planet Check Character



@SETUPE0  
\*\* Exit Setup





@SETUPE1  
**Enter Setup**

## KIX Post

### Restore Factory Defaults



@KIXDEF  
**Restore the Factory Defaults of KIX Post**

### Enable/Disable KIX Post



@KIXENA1  
**Enable KIX Post**



@KIXENA0  
**\*\* Disable KIX Post**



If the scanner fails to identify KIX Post barcodes, you may first try this solution by scanning the **Enter Setup** barcode and then **Enable KIX Post** barcode.



@SETUPE0  
**\*\* Exit Setup**



@SETUPE1  
**Enter Setup**

---

## Australian Postal

### Restore Factory Defaults



@APLDEF  
**Restore the Factory Defaults of Australian Postal**

### Enable/Disable Australian Postal



@APLENA1  
**Enable Australian Postal**



@APLENA0  
**\*\* Disable Australian Postal**



If the scanner fails to identify Australian Postal barcodes, you may first try this solution by scanning the **Enter Setup** barcode and then **Enable Australian Postal** barcode.



@SETUPE0  
**\*\* Exit Setup**



@SETUPE1  
Enter Setup

---

## Japan Post

### Restore Factory Defaults



@JPPDEF  
Restore the Factory Defaults of Japan Post

### Enable/Disable Japan Post

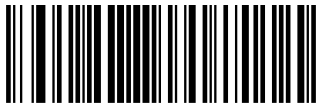

@JPPENA1  
Enable Japan Post



@JPPENA0  
\*\* Disable Japan Post

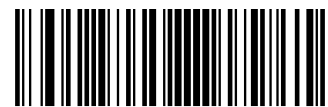

@SETUPE0  
\*\* Exit Setup



@SETUPE1  
Enter Setup

---

## Specific OCR-B

### Restore Factory Defaults



@SOBDEF  
Restore the Factory Defaults of Specific OCR-B

### Enable/Disable Specific OCR-B



@SOBENA1  
Enable Specific OCR-B



@SOBENA0  
**\*\* Disable Specific OCR-B**



If the scanner fails to identify Specific OCR-B barcodes, you may first try this solution by scanning the **Enter Setup** barcode and then **Enable Specific OCR-B** barcode.



@SETUPE0  
**\*\* Exit Setup**



@SETUPE1  
**Enter Setup**

---

## Chinese ID Card OCR

### Restore Factory Defaults



@IDCDEF

**Restore the Factory Defaults of Chinese ID Card OCR**

### Enable/Disable Chinese ID Card OCR



@IDCENA1

**Enable Chinese ID Card OCR**



@IDCENA0

**\*\* Disable Chinese ID Card OCR**



If the scanner fails to identify Chinese ID Card OCR barcodes, you may first try this solution by scanning the **Enter Setup** barcode and then **Enable Chinese ID Card OCR** barcode.



@SETUPE0  
**\*\* Exit Setup**



@SETUPE1  
Enter Setup

---

## Passport OCR

### Restore Factory Defaults



@PASDEF  
Restore the Factory Defaults of Passport OCR

### Enable/Disable Passport OCR



@PASENA1  
Enable Passport OCR



@PASENA0  
**\*\* Disable Passport OCR**



If the scanner fails to identify Passport OCR barcodes, you may first try this solution by scanning the **Enter Setup** barcode and then **Enable Passport OCR** barcode.



@SETUPE0  
**\*\* Exit Setup**



@SETUPE1  
**Enter Setup**

---

## China Travel Permit OCR

### Restore Factory Defaults



@CTPDEF

**Restore the Factory Defaults of China Travel Permit OCR**

### Enable/Disable China Travel Permit OCR



@CTPEN A1

**Enable China Travel Permit OCR**



@CTPEN A0

**\*\* Disable China Travel Permit OCR**



If the scanner fails to identify China Travel Permit OCR barcodes, you may first try this solution by scanning the **Enter Setup** barcode and then **Enable China Travel Permit OCR** barcode.



@SETUPE0  
**\*\* Exit Setup**



@SETUPE1  
Enter Setup

# Chapter 7 Data Formatter

## Introduction

You may use the Data Formatter to modify the scanner’s output. For example, you can use the Data Formatter to insert characters at certain points in barcode data or to suppress/ replace/ send certain characters in barcode data as it is scanned. Normally, when you scan a barcode, it gets outputted automatically; however, when you create a format, you must use a “send” command (see the “Send Commands” section in this chapter) within the format programming to output data. Multiple data formats can be programmed into the scanner. The maximum size of all data formats created is 2048 characters. By default, the data formatter is disabled. Enable it when required. If you have changed data format settings, and wish to clear all formats and return to the factory defaults, scan the **Default Data Format** code below.



@DFMDEF  
Default Data Format

## Add a Data Format

Data format is used to edit barcode data. When you create a data format, you must select one of the four labels (Format\_0, Format\_1, Format\_2 and Format\_3) for your data format, specify the application scope of data format (such as barcode type and data length) and include formatter commands. Multiple data formats may be created using the same label. When scanned data does not match your data format requirements, you will hear the non-match error beep (if the non-match error beep is ON).

There are two methods to program a data format: Programming with barcodes and programming with serial commands.

### Programming with Barcodes

The following explains how to program a data format by scanning the specific barcodes. Scanning any irrelevant barcode or failing to follow the setting procedure will result in programming failure. To find the alphanumeric barcodes needed to create a data format, see the “Digit Barcodes” section in Appendix.

**Step 1:** Scan the **Enter Setup** barcode.



@SETUPE0  
\*\* Exit Setup





@SETUPE1  
Enter Setup

---

**Step 2:** Scan the **Add Data Format** barcode.



@DFMADD  
**Add Data Format**

**Step 3:** Select a label (Format\_0 or Format\_1 or Format\_2 or Format\_3).

Scan a numeric barcode **0** or **1** or **2** or **3** to label this data format Format\_0 or Format\_1 or Format\_2 or Format\_3.

**Step 4:** Select formatter command type.

Specify what type of formatter commands will be used. Scan a numeric barcode **6** to select formatter command type 6. (See the “Formatter Command Type 6” section in this chapter for more information)

**Step 5:** Set interface type

Scan **999** for any interface type.

**Step 6:** Set Symbology ID Number

Refer to the “Symbology ID Number” section in Appendix and find the ID number of the symbology to which you want to apply the data format. Scan three numeric barcodes for the symbology ID number. If you wish to create a data format for all symbologies, scan **999**.

**Step 7:** Set barcode data length

Specify what length of data will be acceptable for this symbology. Scan the four numeric barcodes that represent the data length. 9999 is a universal number, indicating all lengths. For example, 32 characters should be entered as 0032.

**Step 8:** Enter formatter command

Refer to the “Formatter Command Type 6” section in this chapter. Scan the alphanumeric barcodes that represent the command you need to edit data. For example, when a command is F141, you should scan F141.

**Step 9:** Scan the **Save** barcode from the “Save/Cancel Barcodes” section in Appendix to save your data format.

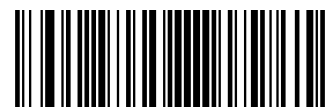

@SETUPE0  
**\*\* Exit Setup**



@SETUPE1  
**Enter Setup**

---

**Example:** Program a Format\_0 data format using formatter command type 6, Code 128 containing 10 characters applicable, send all characters followed by "A".

- |   |   |
|---|---|
| 1. Scan the <b>Enter Setup</b> barcode        | Enter the Setup mode                          |
| 2. Scan the <b>Add Data Format</b> barcode    | Add a data format                             |
| 3. Scan the <b>0</b> barcode                  | Select Format_0 as the label                  |
| 4. Scan the <b>6</b> barcode                  | Select formatter command type 6               |
| 5. Scan the <b>9</b> barcode three times      | All interface types applicable                |
| 6. Scan the barcodes <b>002</b>               | Only Code 128 applicable                      |
| 7. Scan the barcodes <b>0010</b>              | Only a length of 10 characters applicable     |
| 8. Scan the alphanumeric barcodes <b>F141</b> | Send all characters followed by "A" (HEX: 41) |
| 9. Scan the <b>Save</b> barcode               | Save the data format                          |

To streamline the programming process, you may as well generate a batch barcode by inputting the command (e.g. **@DFMADD069990020010F141**;) used to create a data format. See the "Use Batch Barcode" section in Chapter 9 to learn how to put a batch barcode into use.

When creating multiple data formats sharing a label, the formats are separated from each other by a vertical bar (|) in the batch command, e.g. **@DFMADD069990029999F141|069990039999F142|169990049999F143**;



@SETUPE0  
**\*\* Exit Setup**



@SETUPE1  
Enter Setup

## Programming with Serial Commands

A data format can also be created by serial commands (HEX) sent from the host device. **All commands must be entered in uppercase letters.**

The syntax consists of the following elements:

**Prefix:** “~<SOH>0000” (HEX: **7E 01 30 30 30 30**), 6 characters.

**Storage type:** “@” (HEX: **40**) or “#” (HEX: **23**), 1 character. “@” means permanent setting which will not be lost by removing power from the scanner or rebooting it; “#” means temporary setting which will be lost by removing power from the scanner or rebooting it.

**Add Data Format Command:** “DFMADD” (HEX: **44 46 4D 41 44 44**), 6 characters.

**Data format label:** “0” (HEX: **30**) or “1” (HEX: **31**) or “2” (HEX: **32**) or “3” (HEX: **33**), 1 character. “0”, “1”, “2” and “3” represent Format\_0, Format\_1, Format\_2 and Format\_3 respectively.

**Formatter command type:** “6” (HEX: **36**), 1 character.

**Interface type:** “999” (HEX: **39 39 39**), 3 characters.

**Symbology ID Number:** The ID number of the symbology to which you want to apply the data format, 3 characters. 999 indicates all symbologies.

**Data length:** The length of data that will be acceptable for this symbology, 4 characters. 9999 indicates all lengths. For example, 32 characters should be entered as 0032.

**Formatter commands:** The command string used to edit data. For more information, see the “Formatter Command Type 6” section in this chapter.

**Suffix:** “;<ETX>” (HEX: **3B 03**), 2 characters.

**Example:** Program a Format\_0 data format using formatter command type 6, Code 128 containing 10 characters applicable, send all characters followed by “A”.

Enter: **7E 01 30 30 30 30 40 44 46 4D 41 44 44 30 36 39 39 39 30 30 33 39 39 39 39 46 31 34 31 3B 03**  
(~<SOH>0000@DFMADD069990020010F141;<ETX>)

Response: **02 01 30 30 30 30 40 44 46 4D 41 44 44 30 36 39 39 39 30 30 33 39 39 39 39 46 31 34 31 06 3B 03**  
(<STX><SOH>0000@DFMADD069990020010F141<ACK>;<ETX>)

When creating multiple data formats sharing a label, the formats are separated from each other by a vertical bar (|) in the serial command.

**Example:** ~<SOH>0000@DFMADD069990020010F141|069990039999F142|069990049999F143;<ETX>

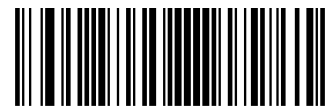

@SETUPE0  
\*\* Exit Setup



@SETUPE1  
Enter Setup

---

## Enable/Disable Data Formatter

When Data Formatter is disabled, the data format you have enabled becomes invalid.



@DFMENA0  
**\*\* Disable Data Formatter**

You may wish to require the data to conform to a data format you have created. The following settings can be applied to your data format:

**Enable Data Formatter, Required, Keep Prefix/Suffix:** Scanned data that meets your data format requirements is modified accordingly and gets outputted along with prefixes and suffixes (if prefix and suffix are enabled). Any data that does not match your data format requirements generates an error beep (if Non-Match Error Beep is turned ON) and the data in that barcode is not transmitted.

**Enable Data Formatter, Required, Drop Prefix/Suffix:** Scanned data that meets your data format requirements is modified accordingly and gets outputted without prefixes and suffixes (even if prefix and suffix are enabled). Any data that does not match your data format requirements generates an error beep (if Non-Match Error Beep is turned ON) and the data in that barcode is not transmitted.

**Enable Data Formatter, Not Required, Keep Prefix/Suffix:** Scanned data that meets your data format requirements is modified accordingly and gets outputted along with prefixes and suffixes (if prefix and suffix are enabled). Barcode data that does not match your data format requirements is transmitted as read along with prefixes and suffixes (if prefix and suffix are enabled).

**Enable Data Formatter, Not Required, Drop Prefix/Suffix:** Scanned data that meets your data format requirements is modified accordingly and gets outputted without prefixes and suffixes (even if prefix and suffix are enabled). Barcode data that does not match your data format requirements is transmitted as read along with prefixes and suffixes (if prefix and suffix are enabled).



@SETUPE0  
**\*\* Exit Setup**



@SETUPE1  
Enter Setup



@DFMENA1

**Enable Data Formatter, Required, Keep Prefix/Suffix**



@DFMENA2

**Enable Data Formatter, Required, Drop Prefix/Suffix**



@DFMENA3

**Enable Data Formatter, Not Required, Keep Prefix/Suffix**



@DFMENA4

**Enable Data Formatter, Not Required, Drop Prefix/Suffix**

## Non-Match Error Beep

If Non-Match Error Beep is turned ON, the scanner generates an error beep when a barcode is encountered that does not match your required data format.

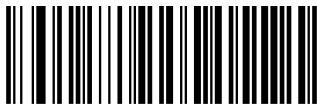

@DFMTON0

**Non-Match Error Beep Off**



@DFMTON1

**\*\* Non-Match Error Beep On**

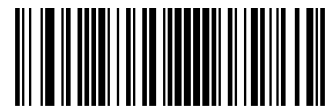

@SETUPE0  
**\*\* Exit Setup**



@SETUPE1  
**Enter Setup**

---

## Data Format Selection

After enabling the Data Formatter, you can select a data format you want to use by scanning the appropriate barcode below.



@DFMUSE0  
**\*\* Format\_0**



@DFMUSE2  
**Format\_2**



@DFMUSE1  
**Format\_1**



@DFMUSE3  
**Format\_3**



@SETUPE0  
**\*\* Exit Setup**



@SETUPE1  
**Enter Setup**

---

## Change Data Format for a Single Scan

You can switch between data formats for a single scan. The next barcode is scanned using the data format selected here, then reverts to the format you have selected above.

For example, you may have set your scanner to use the data format you saved as Format\_3. You can switch to Format\_1 for a single trigger pull by scanning the **Single Scan – Format\_1** barcode below. The next barcode that is scanned uses Format\_1, then reverts back to Format\_3.

Note: This setting will be lost by removing power from the scanner, or turning off/ rebooting the device.



@DFMSIN0  
**Single Scan – Format\_0**



@DFMSIN2  
**Single Scan – Format\_2**



@DFMSIN1  
**Single Scan – Format\_1**



@DFMSIN3  
**Single Scan – Format\_3**

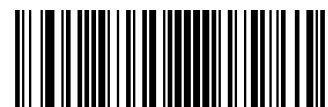

@SETUPE0  
**\*\* Exit Setup**



@SETUPE1  
Enter Setup

---

## Clear Data Format

There are two methods to remove data format created from your scanner:

Delete one data format: Scan the **Clear One** barcode, a numeric barcode (0-3) and the **Save** barcode. For example, to delete Format\_2, you should scan the **Clear One** barcode, the **2** barcode and the **Save** barcode

Delete all data formats: Scan the **Clear All** barcode.

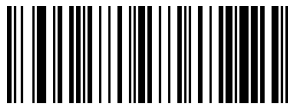

@DFMCAL  
Clear All



@DFMCLR  
Clear One

## Query Data Formats

You may scan the appropriate barcode below to get the information of data format(s) created by you or preset by manufacturer. For instance, if you have added Format\_0 as per the example in the “Add a Data Format” section in this chapter, scanning the **Query Current Data Formats** barcode, you will get the result: **Data Format0:069990020010F141;**



@DFMQCU  
Query Current Data Formats



@DFMQFA  
Query Preset Data Formats



@SETUPE0  
\*\* Exit Setup





@SETUPE1  
Enter Setup

## Formatter Command Type 6

When working with the Data Formatter, a virtual cursor is moved along your input data string. The following commands are used to both move this cursor to different positions, and to select, replace, and insert data into the final output. For the hex value of ASCII characters involved in the commands, refer to the “ASCII Table” in Appendix.

### Send Commands

#### F1 Send all characters

Syntax=F1xx (xx: The insert character’s hex value)

Include in the output message all of the characters from the input message, starting from current cursor position, followed by an insert character.

#### F2 Send a number of characters

Syntax=F2nxx (nn: The numeric value (00-99) for the number of characters; xx: The insert character’s hex value)

Include in the output message a number of characters followed by an insert character. Start from the current cursor position and continue for “nn” characters or through the last character in the input message, followed by character “xx.”

#### F2 Example: Send a number of characters



Send the first 10 characters from the barcode above, followed by a carriage return.

Command string: **F2100D**

F2 is the “Send a number of characters” command

10 is the number of characters to send

0D is the hex value for a CR

The data is output as: **1234567890**

**<CR>**



@SETUPE0  
\*\* Exit Setup



@SETUPE1  
Enter Setup

---

### F3 Send all characters up to a particular character

Syntax=F3ssxx (ss: The particular character's hex value; xx: The insert character's hex value)

Include in the output message all characters from the input message, starting with the character at the current cursor position and continuing to, but not including, the particular character "ss," followed by character "xx." The cursor is moved forward to the "ss" character.

#### F3 Example: Send all characters up to a particular character



Using the barcode above, send all characters up to but not including "D," followed by a carriage return.

Command string: **F3440D**

F3 is the "Send all characters up to a particular character" command

44 is the hex value for a "D"

0D is the hex value for a CR

The data is output as: **1234567890ABC**  
**<CR>**

### E9 Send all but the last characters

Syntax=E9nn (nn: The numeric value (00-99) for the number of characters that will not be sent at the end of the message)

Include in the output message all but the last "nn" characters, starting from the current cursor position. The cursor is moved forward to one position past the last input message character included.

### F4 Insert a character multiple times

Syntax=F4xxnn (xx: The insert character's hex value; nn: The numeric value (00-99) for the number of times it should be sent)

Send "xx" character "nn" times in the output message, leaving the cursor in the current position.



@SETUPE0  
**\*\* Exit Setup**



@SETUPE1  
Enter Setup

---

**E9 and F4 Example: Send all but the last characters, followed by 2 tabs**



Send all characters except for the last 8 from the barcode above, followed by 2 tabs.

Command string: **E908F40902**

E9 is the “Send all but the last characters” command

08 is the number of characters at the end to ignore

F4 is the “Insert a character multiple times” command

09 is the hex value for a horizontal tab

02 is the number of time the tab character is sent

The data is output as: **1234567890AB<tab><tab>**

**B3 Insert symbology name**

Insert the name of the barcode’s symbology in the output message, without moving the cursor.

**B4 Insert barcode length**

Insert the barcode’s length in the output message, without moving the cursor. The length is expressed as a numeric string and does not include leading zeros.

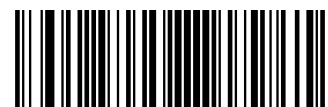

@SETUPE0  
\*\* Exit Setup



@SETUPE1  
Enter Setup

---

### B3 and B4 Example: Insert the symbology name and length



Send the symbology name and length before the barcode data from the barcode above. Break up these insertions with spaces. End with a carriage return.

Command string: **B3F42001B4F42001F10D**

B3 is the "Insert symbology name" command

F4 is the "Insert a character multiple times" command

20 is the hex value for a space

01 is the number of time the space character is sent

B4 is the "Insert barcode length" command

F4 is the "Insert a character multiple times" command

20 is the hex value for a space

01 is the number of time the space character is sent

F1 is the "Send all characters" command

0D is the hex value for a CR

The data is output as: **Code128 20 1234567890ABCDEFGHIJ**

**<CR>**

## Move Commands

### F5 Move the cursor forward a number of characters

Syntax=F5nn (nn: The numeric value (00-99) for the number of characters the cursor should be moved ahead)

Move the cursor ahead "nn" characters from current cursor position.



@SETUPE0  
**\*\* Exit Setup**



@SETUPE1  
Enter Setup

---

**F5 Example: Move the cursor forward and send the data**



Move the cursor forward 3 characters, then send the rest of the barcode data from the barcode above. End with a carriage return.

Command string: **F503F10D**

F5 is the “Move the cursor forward a number of characters” command

03 is the number of characters to move the cursor

F1 is the “Send all characters” command

0D is the hex value for a CR

The data is output as: **4567890ABCDEFGHIJ**

**<CR>**

**F6 Move the cursor backward a number of characters**

Syntax=F6nn (nn: The numeric value (00-99) for the number of characters the cursor should be moved back)

Move the cursor back “nn” characters from current cursor position.

**F7 Move the cursor to the beginning**

Syntax=F7

Move the cursor to the first character in the input message.

**EA Move the cursor to the end**

Syntax=EA

Move the cursor to the last character in the input message.

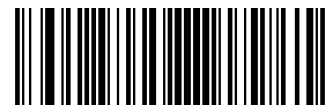

@SETUPE0  
\*\* Exit Setup



@SETUPE1  
Enter Setup

---

## Search Commands

### F8 Search forward for a character

Syntax = F8xx (xx: The search character's hex value)

Search the input message forward for "xx" character from the current cursor position, leaving the cursor pointing to the "xx" character.

### F8 Example: Send barcode data that starts after a particular character



Search for the letter "D" in barcodes and send all the data that follows, including the "D". Using the barcode above:

Command string: **F844F10D**

F8 is the "Search forward for a character" command

44 is the hex value for "D"

F1 is the "Send all characters" command

0D is the hex value for a CR

The data is output as: **DEFGHIJ**

**<CR>**

### F9 Search backward for a character

Syntax = F9xx(xx: The search character's hex value)

Search the input message backward for "xx" character from the current cursor position, leaving the cursor pointing to the "xx" character.



@SETUPE0  
\*\* Exit Setup



@SETUPE1  
Enter Setup

### B0 Search forward for a string

Syntax=B0nnnnS (nnnn: The string length (up to 9999); S: The ASCII hex value of each character in the string)

Search forward for “S” string from the current cursor position, leaving cursor pointing to “S” string. For example, B0000454657374 will search forward for the first occurrence of the 4-character string “Test.”

### B0 Example: Send barcode data that starts after a string of characters



Search for the letters “FGH” in barcodes and send all the data that follows, including “FGH.” Using the barcode above:

Command string: **B00003464748F10D**

B0 is the “Search forward for a string” command

0003 is the string length (3 characters)

46 is the hex value for “F”

47 is the hex value for “G”

48 is the hex value for “H”

F1 is the “Send all characters” command

0D is the hex value for a CR

The data is output as: **FGHIJ**

**<CR>**

### B1 Search backward for a string

Syntax=B1nnnnS (nnnn: The string length (up to 9999); S: The ASCII hex value of each character in the string)

Search backward for “S” string from the current cursor position, leaving cursor pointing to “S” string. For example, B1000454657374 will search backward for the first occurrence of the 4-character string “Test.”

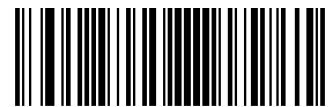

@SETUPE0  
\*\* Exit Setup



@SETUPE1  
Enter Setup

---

### E6 Search forward for a non-matching character

Syntax=E6xx (xx: The search character's hex value)

Search the input message forward for the first non-"xx" character from the current cursor position, leaving the cursor pointing to the non-"xx" character.

#### E6 Example: Remove zeros at the beginning of barcode data



This example shows a barcode that has been zero filled. You may want to ignore the zeros and send all the data that follows. E6 searches forward for the first character that is not zero, then sends all the data after, followed by a carriage return. Using the barcode above:

Command string: **E630F10D**

E6 is the "Search forward for a non-matching character" command

30 is the hex value for 0

F1 is the "Send all characters" command

0D is the hex value for a CR

The data is output as: **37692**

**<CR>**

### E7 Search backward for a non-matching character

Syntax=E7xx(xx: The search character's hex value)

Search the input message backward for the first non-"xx" character from the current cursor position, leaving the cursor pointing to the non-"xx" character.



@SETUPE0  
\*\* Exit Setup





@SETUPE1  
Enter Setup

## Miscellaneous Commands

### FB Suppress characters

Syntax = FBnnxyy..zz (nn: The numeric value (00-15) for the number of suppressed characters; xyy..zz: The hex value of the characters to be suppressed)

Suppress all occurrences of up to 15 different characters, starting at the current cursor position, as the cursor is advanced by other commands.

#### FB Example: Remove spaces in barcode data



This example shows a barcode that has spaces in the data. You may want to remove the spaces before sending the data. Using the barcode above:

Command string: **FB0120F10D**

FB is the "Suppress characters" command

01 is the number of the characters to be suppressed

20 is the hex value for a space

F1 is the "Send all characters" command

0D is the hex value for a CR

The data is output as: **34567890**

**<CR>**

### E4 Replace characters

Syntax = E4nnxx<sub>1</sub>xx<sub>2</sub>yy<sub>1</sub>yy<sub>2</sub>...zz<sub>1</sub>zz<sub>2</sub>(nn: The total count of the number of characters (characters to be replaced plus replacement characters; xx<sub>1</sub>: The characters to be replaced, xx<sub>2</sub>: The replacement characters, continuing through zz<sub>1</sub> and zz<sub>2</sub>)

Replace up to 15 characters in the output message, without moving the cursor.



@SETUPE0  
\*\* Exit Setup



@SETUPE1  
Enter Setup

---

#### E4 Example: Replace zeros with CRs in barcode data



If the barcode has characters that the host application does not want included, you can use the E4 command to replace those characters with something else. In this example, you will replace the zeros in the barcode above with carriage returns.

Command string: **E402300DF10D**

E4 is the "Replace characters" command

02 is the total count of characters to be replaced, plus the replacement characters (0 is replaced by CR, so total characters=2)

30 is the hex value for 0

0D is the hex value for a CR (the character that will replace the 0)

F1 is the "Send all characters" command

0D is the hex value for a CR

The data is output as: **1234**

**5678**

**ABC**

**<CR>**



@SETUPE0  
\*\* Exit Setup



@SETUPE1  
Enter Setup

---

### BA Replace a string with another

Syntax = BAnnNN<sub>1</sub>SS<sub>1</sub>NN<sub>2</sub>SS<sub>2</sub>

nn: The count of replacements to be made, if nn=00 or nn>=the number of occurrences of a string to be replaced, then replace all occurrences of that string.

NN<sub>1</sub>: The length of the string to be replaced, NN<sub>1</sub>>0.

SS<sub>1</sub>: The ASCII hex value of each character in the string to be replaced.

NN<sub>2</sub>: The length of replacement string, NN<sub>2</sub>>=0. To replace string "SS<sub>1</sub>" with NUL (i.e. delete string "SS<sub>1</sub>"), you should set NN<sub>2</sub> to 00 and leave out SS<sub>2</sub>.

SS<sub>2</sub>: The ASCII hex value of each character in the replacement string.

From the current cursor position, search forward for the occurrence of "SS<sub>1</sub>" string (of length "NN<sub>1</sub>") and replace the string with "SS<sub>2</sub>" string (of length "NN<sub>2</sub>") in the output message until every "SS<sub>1</sub>" string is replaced or the count of replacements made reaches "nn" times, without moving the cursor.

### BA Example: Replace "23"s with "ABC"s in barcode data



cd123abc23bc12ab232

If the barcode has a string of characters that the host application does not want included, you can use the BA command to replace the string with something else. In this example, you will replace the "23"s in the barcode above with "ABC"s.

Command string: **BA0002323303414243F100**

BA is the "Replace a string with another" command

00 is the count of replacements to be made, 00 means to replace all occurrences of that string

02 is the length of the string to be replaced

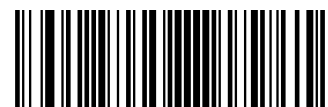

@SETUPE0  
\*\* Exit Setup



@SETUPE1  
**Enter Setup**

---

32 is the hex value for 2 (character in the string to be replaced)

33 is the hex value for 3 (character in the string to be replaced)

03 is the length of the replacement string

41 is the hex value for A (character in the replacement string)

42 is the hex value for B (character in the replacement string)

43 is the hex value for C (character in the replacement string)

F1 is the "Send all characters" command

00 is the hex value for a NUL

The data is output as: **cd1ABCabcABCbc12abABC2**

**BA Example: Remove only the first occurrence of "23"s in barcode data**

If the barcode has a string of characters that the host application wants removed, you can use the BA command to replace the string with NUL. In this example, you will remove the first occurrence of "23" in the barcode above.

Command string: **BA0102323300F100**

BA is the "Replace a string with another" command

01 is the count of replacements to be made

02 is the length of the string to be replaced

32 is the hex value for 2 (character in the string to be replaced)

33 is the hex value for 3 (character in the string to be replaced)

00 is the length of the replacement string, 00 means to replace the string to be replaced with NUL

F1 is the "Send all characters" command

00 is the hex value for a NUL

The data is output as: **cd1abc23bc12ab232**



@SETUPE0  
**\*\* Exit Setup**



@SETUPE1  
Enter Setup

---

### EF Insert a delay

Syntax = EFnnnn (nnnn: The delay in 5ms increments, up to 9999)

Inserts a delay of up to 49,995 milliseconds (in multiples of 5), starting from the current cursor position. This command can only be used with USB HID Keyboard.

### EF Example: Insert a delay of 1s between the 5<sup>th</sup> and 6<sup>th</sup> character

Send the first 5 characters in a barcode, wait for 1s, then send the rest of the barcode data.

Command string: **F20500EF0200E900**

F2 is the "Send a number of characters" command

05 is the number of characters to send

00 is the hex value for a Null character

EF is the "Insert a delay" command

0200 is the delay value (5msX200=1000ms=1s)

E9 is the "Send all but the last characters" command

00 is the number of characters that will not be sent at the end of the message

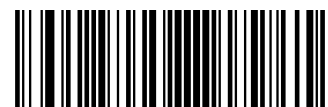

@SETUPE0  
\*\* Exit Setup



@SETUPE1  
Enter Setup

---

### B5 Insert key strokes

Syntax=B5nnssxx (nn: The number of keys pressed (without key modifiers); ss: the key modifier from the table below; xx: the key number from the “Unicode Key Maps” in Appendix.)

Insert a key stroke or combination of key strokes. Key strokes are dependent on your keyboard (see the “Unicode Key Maps” in Appendix). This command can only be used with USB HID Keyboard.

Key Modifiers	
No Key Modifier	00
Shift Left	01
Shift Right	02
Alt Left	04
Alt Right	08
Control Left	10
Control Right	20

For example, B501001F inserts an “a” on a U.S. style keyboard. B5 = the command, 01 = number of keys pressed (without the key modifier), 00 is No Key Modifier, and 1F is the “a” key. If an “A” were to be inserted, B501011F or B501021F would be entered.

If there are two keystrokes, the syntax would change from Syntax=B5nnssxx for one keystroke to Syntax=B5nnssxxssxx. An example that would insert “aA” is as follows: B502001F011F.

Note: Key modifiers can be added together when needed. Example: Shift Left + Alt Left + Control Left =15.



@SETUPE0  
\*\* Exit Setup



@SETUPE1  
Enter Setup

## Chapter 8 Prefix & Suffix

### Introduction

A 1D barcode could contain digits, letters, symbols, etc. A 2D barcode could contain more data, such as Chinese characters and other multi-byte characters. However, in real applications, they do not and should not have all information we need, such as barcode type, data acquisition time and delimiter, in order to keep the barcodes short and flexible.

Prefix and suffix are how to fulfill the needs mentioned above. They can be added, removed and modified while the original barcode data remains intact.



Barcode processing procedure:

1. Edit data with Data Formatter
2. Append prefix/suffix
3. Pack data
4. Append terminating character



@SETUPE0  
\*\* Exit Setup



@SETUPE1  
Enter Setup

---

## Global Settings

### Enable/Disable All Prefixes/Suffixes

**Disable All Prefixes/Suffixes:** Transmit barcode data with no prefix/suffix.

**Enable All Prefixes/Suffixes:** Allow to append Code ID prefix, AIM ID prefix, custom prefix/suffix and terminating character to the barcode data before the transmission.



@APSENA0  
**\*\* Disable All Prefixes/Suffixes**



@APSENA1  
**Enable All Prefixes/Suffixes**

## Prefix Sequence



@PRESEQ0  
**\*\* Code ID+ Custom +AIM ID**



@PRESEQ1  
**Custom + Code ID + AIM ID**



@SETUPE0  
**\*\* Exit Setup**





@SETUPE1  
Enter Setup

## Custom Prefix

### Enable/Disable Custom Prefix

If custom prefix is enabled, you are allowed to append to the data a user-defined prefix that cannot exceed 10 characters. For example, if the custom prefix is “AB” and the barcode data is “123”, the Host will receive “AB123”.



@CPRENA0  
\*\* Disable Custom Prefix



@CPRENA1  
Enable Custom Prefix

### Set Custom Prefix

To set a custom prefix, scan the **Set Custom Prefix** barcode then the numeric barcodes corresponding to the hexadecimal value of a desired prefix then the **Save** barcode.

**Note:** A custom prefix cannot exceed 10 characters.



@CPRSET  
Set Custom Prefix

**E**  
*xample*

**Set the custom prefix to “CODE” (HEX: 0x43/0x4F/0x44/0x45):**

1. Scan the **Enter Setup** barcode.
2. Scan the **Set Custom Prefix** barcode.
3. Scan the numeric barcodes “4”, “3”, “4”, “F”, “4”, “4”, “4” and “5” from the “Digit Barcodes” section in Appendix.
4. Scan the **Save** barcode from the “Save/Cancel Barcodes” section in Appendix.
5. Scan the **Enable Custom Prefix** barcode.
6. Scan the **Exit Setup** barcode.

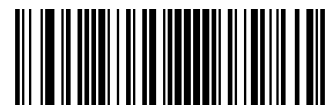

@SETUPE0  
\*\* Exit Setup



@SETUPE1  
**Enter Setup**

---

## AIM ID Prefix

AIM (Automatic Identification Manufacturers) ID defines symbology identifier (For the details, see the “AIM ID Table” section in Appendix). If AIM ID prefix is enabled, the scanner will add the symbology identifier before the scanned data after decoding.



@AIDENA0  
**\*\* Disable AIM ID Prefix**



@AIDENA1  
**Enable AIM ID Prefix**



AIM ID is not user programmable.



@SETUPE0  
**\*\* Exit Setup**



@SETUPE1  
**Enter Setup**

---

## Code ID Prefix

Code ID can also be used to identify barcode type. Unlike AIM ID, Code ID is user programmable. Code ID can only consist of one or two English letters.



@CIDENA0  
**\*\* Disable Code ID Prefix**



@CIDENA1  
**Enable Code ID Prefix**

## Restore All Default Code IDs

For the information of default Code IDs, see the "Code ID Table" section in Appendix.



@CIDDEF  
**Restore All Default Code IDs**

## Modify Code ID

See the examples below to learn how to modify a Code ID and restore the default Code IDs of all symbologies.



@SETUPE0  
**\*\* Exit Setup**



@SETUPE1  
Enter Setup

---

**E**  
*xample*

**Modify PDF417 Code ID to be “p” (HEX: 0x70):**

1. Scan the **Enter Setup** barcode.
2. Scan the **Modify PDF417 Code ID** barcode.
3. Scan the numeric barcodes “7” and “0” from the “Digit Barcodes” section in Appendix.
4. Scan the **Save** barcode from the “Save/Cancel Barcodes” section in Appendix.
5. Scan the **Exit Setup** barcode.

**Restore the default Code IDs of all symbologies:**

1. Scan the **Enter Setup** barcode.
2. Scan the **Restore All Default Code IDs** barcode.
3. Scan the **Exit Setup** barcode.



@SETUPE0  
\*\* Exit Setup



@SETUPE1

**Enter Setup**

---

**1D symbologies:**



@CID002

**Modify Code 128 Code ID**



@CID003

**Modify GS1-128 Code ID**



@CID004

**Modify EAN-8 Code ID**



@CID005

**Modify EAN-13 Code ID**



@CID006

**Modify UPC-E Code ID**



@CID007

**Modify UPC-A Code ID**



@CID008

**Modify Interleaved 2 of 5 Code ID**



@SETUPE0

**\*\* Exit Setup**



@SETUPE1  
**Enter Setup**

---



@CID009  
**Modify ITF-14 Code ID**



@CID010  
**Modify ITF-6 Code ID**



@CID011  
**Modify Matrix 2 of 5 Code ID**



@CID013  
**Modify Code 39 Code ID**



@CID015  
**Modify Codabar Code ID**



@CID017  
**Modify Code 93 Code ID**



@CID019  
**Modify China Post 25 Code ID**



@CID020  
**Modify AIM 128 Code ID**



@SETUPE0  
**\*\* Exit Setup**



@SETUPE1  
**Enter Setup**

---



@CID021  
**Modify ISBT 128 Code ID**



@CID022  
**Modify COOP 25 Code ID**



@CID023  
**Modify ISSN Code ID**



@CID024  
**Modify ISBN Code ID**



@CID025  
**Modify Industrial 25 Code ID**



@CID026  
**Modify Standard 25 Code ID**



@CID027  
**Modify Plessey Code ID**



@CID028  
**Modify Code 11 Code ID**



@SETUPE0  
**\*\* Exit Setup**



@SETUPE1  
**Enter Setup**

---



@CID029  
**Modify MSI-Plessy Code ID**



@CID030  
**Modify GS1 Composite Code ID**



@CID031  
**Modify GS1 Databar Code ID**



@CID132  
**Modify Code 49 Code ID**



@CID133  
**Modify Code 16K Code ID**



@SETUPE0  
**\*\* Exit Setup**





@SETUPE1  
Enter Setup

---

2D symbologies:



@CID032  
Modify PDF417 Code ID



@CID034  
Modify Aztec Code ID



@CID036  
Modify Maxicode Code ID



@CID041  
Modify GM Code ID



@CID033  
Modify QR Code ID



@CID035  
Modify Data Matrix Code ID



@CID039  
Modify Chinese Sensible Code ID



@SETUPE0  
\*\* Exit Setup



@SETUPE1  
**Enter Setup**

---



@CID042  
**Modify Micro PDF417 Code ID**



@CID043  
**Modify Micro QR Code ID**



@CID048  
**Modify Code One Code ID**



@SETUPE0  
**\*\* Exit Setup**



@SETUPE1  
Enter Setup

---

### OCR symbologies



@CID064  
Specific OCR-B



@CID066  
Passport OCR



@CID065  
Chinese ID Card OCR



@CID068  
China Travel Permit OCR



@SETUPE0  
\*\* Exit Setup



@SETUPE1  
Enter Setup

---

**Postal symbologies:**



@CID096  
**Modify USPS Postnet Code ID**



@CID097  
**Modify USPS Intelligent Mail Code ID**



@CID098  
**Modify Royal Mail Code ID**



@CID099  
**Modify USPS Planet Code ID**



@CID100  
**Modify KIX Post Code ID**



@CID101  
**Modify Australian Postal Code ID**



@CID102  
**Modify Japan Post Code ID**



@SETUPE0  
**\*\* Exit Setup**



@SETUPE1

**Enter Setup**

---

**OCR:**



@CID064

**Modify Specific OCR-B Code ID**



@CID065

**Modify Chinese ID Card OCR Code ID**



@CID066

**Modify Passport OCR Code ID**



@CID068

**Modify China Travel Permit OCR Code ID**



@SETUPE0

**\*\* Exit Setup**



@SETUPE1  
Enter Setup

## Custom Suffix

### Enable/Disable Custom Suffix

If custom suffix is enabled, you are allowed to append to the data a user-defined suffix that cannot exceed 10 characters. For example, if the custom suffix is “AB” and the barcode data is “123”, the Host will receive “123AB”.



@CSUENA0  
\*\* Disable Custom Suffix



@CSUENA1  
Enable Custom Suffix

### Set Custom Suffix

To set a custom suffix, scan the **Set Custom Suffix** barcode then the numeric barcodes corresponding to the hexadecimal value of a desired suffix then the **Save** barcode.

**Note:** A custom suffix cannot exceed 10 characters.



@CSUSET  
Set Custom Suffix

**E**  
*sample*

**Set the custom suffix to “CODE” (HEX: 0x43/0x4F/0x44/0x45):**

1. Scan the **Enter Setup** barcode.
2. Scan the **Set Custom Suffix** barcode.
3. Scan the numeric barcodes “4”, “3”, “4”, “F”, “4”, “4”, “4” and “5” from the “Digit Barcodes” section in Appendix.
4. Scan the **Save** barcode from the “Save/Cancel Barcodes” section in Appendix.
5. Scan the **Enable Custom Suffix** barcode.
6. Scan the **Exit Setup** barcode.



@SETUPE0  
\*\* Exit Setup



@SETUPE1  
Enter Setup

---

## Data Packing

### Introduction

Data packing is designed for a specific group of users who want to have the data packed before transmission. Data packing influences data format, so it is advised to disable this feature when it is not required.

### Data Packing Options

- ◇ **Disable Data Packing:** Transmit decoded data in raw format (unpacked).
- ◇ **Enable Data Packing, Format 1:** Transmit decoded data with the packet format 1 defined below.  
Packet format 1: [STX + ATTR + LEN] + [AL\_TYPE + DATA] + [LRC]  
STX: 0x02  
ATTR: 0x00  
LEN: Barcode data length is expressed in 2 bytes ranging from 0x0000 (0) to 0xFFFF (65535).  
AL\_TYPE: 0x36  
DATA: Raw barcode data.  
LRC: Check digit.  
LRC calculation algorithm: computation sequence: 0xFF+LEN+AL\_TYPE+DATA; computation method is XOR, byte by byte.
- ◇ **Enable Data Packing, Format 2:** Transmit decoded data with the packet format 2 defined below.  
Packet format 2: [STX + ATTR + LEN] + [AL\_TYPE] + [Symbology\_ID + DATA] + [LRC]  
STX: 0x02  
ATTR: 0x00  
LEN: Barcode data length is expressed in 2 bytes ranging from 0x0000 (0) to 0xFFFF (65535).  
AL\_TYPE: 0x3B  
Symbology\_ID: The ID number of symbology, 1 byte.  
DATA: Raw barcode data.  
LRC: Check digit.  
LRC calculation algorithm: computation sequence: 0xFF+LEN+AL\_TYPE+Symbology\_ID+DATA; computation method is XOR, byte by byte.

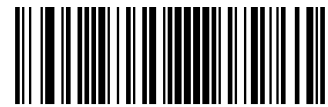

@SETUPE0  
\*\* Exit Setup



@SETUPE1

**Enter Setup**

---



@PACKAG0

**\*\* Disable Data Packing**



@PACKAG1

**Enable Data Packing, Format 1**

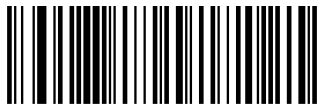

@PACKAG2

**Enable Data Packing, Format 2**



@SETUPE0

**\*\* Exit Setup**





@SETUPE1  
Enter Setup

## Terminating Character Suffix

### Enable/Disable Terminating Character Suffix

A terminating character such as carriage return (CR) or carriage return/line feed pair (CRLF) can only be used to mark the end of data, which means nothing can be added after it.



@TSUENA0

**\*\* Disable Terminating Character Suffix**



@TSUENA1

**Enable Terminating Character Suffix**

### Set Terminating Character Suffix

To set a terminating character suffix, scan the **Set Terminating Character Suffix** barcode then the numeric barcodes corresponding to the hexadecimal value of a desired terminating character then the **Save** barcode.

**Note:** A terminating character suffix cannot exceed 2 characters.



@TSUSET

**Set Terminating Character Suffix**



@TSUSET0D

**Set Terminating Character to CR (0x0D)**



@TSUSET0D0A

**Set Terminating Character to CRLF (0x0D,0x0A)**



@SETUPE0

**\*\* Exit Setup**



@SETUPE1  
**Enter Setup**

---

**E**  
*sample*

**Set the terminating character suffix to 0x0A:**

1. Scan the **Enter Setup** barcode.
2. Scan the **Set Terminating Character Suffix** barcode.
3. Scan the numeric barcodes “0” and “A” from the “Digit Barcodes” section in Appendix.
4. Scan the **Save** barcode from the “Save/Cancel Barcodes” section in Appendix.
5. Scan the **Enable Terminating Character Suffix** barcode.
6. Scan the **Exit Setup** barcode.



@SETUPE0  
**\*\* Exit Setup**



@SETUPE1  
Enter Setup

# Chapter 9 Batch Programming

## Introduction

Batch programming enables users to integrate a batch of commands into a single batch barcode.

Listed below are batch programming rules:

1. Command format: Command + Parameter Value.
2. Each command is terminated by a semicolon (;). Note that there is no space between a command and its terminator semicolon.
3. Use the barcode generator software to generate a 2D batch barcode.

Example: Create a batch barcode for **Illumination Always On, Sense Mode, Decode Session Timeout = 2s**:

1. Input the commands:

@ILLSCN2;SCNMOD2;ORTSET2000;

2. Generate a batch barcode.

When setting up a scanner with the above configuration, scan the **Enable Batch Barcode** barcode and then the batch barcode generated.



@BATCHS  
Enable Batch Barcode

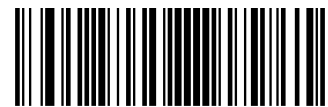

@SETUPE0  
\*\* Exit Setup



@SETUPE1  
Enter Setup

---

## Create a Batch Command

A batch command may contain a number of individual commands each of which is terminated by a semicolon (;).

For more information, refer to the “Use of Programming Command” section in Chapter 3.

## Create a Batch Barcode

Batch barcodes can be produced in the format of PDF417, QR Code or Data Matrix.

Example: Create a batch barcode for **Illumination Always On, Sense Mode, Decode Session Timeout = 2s**:

1. Input the following commands:

```
@ILLSCN2;SCNMOD2;ORTSET2000;
```

2. Generate a PDF417 batch barcode.



@SETUPE0  
\*\* Exit Setup



@SETUPE1  
Enter Setup

---

## Use Batch Barcode

To put a batch barcode into use, scan the following barcodes. (Use the example above.)

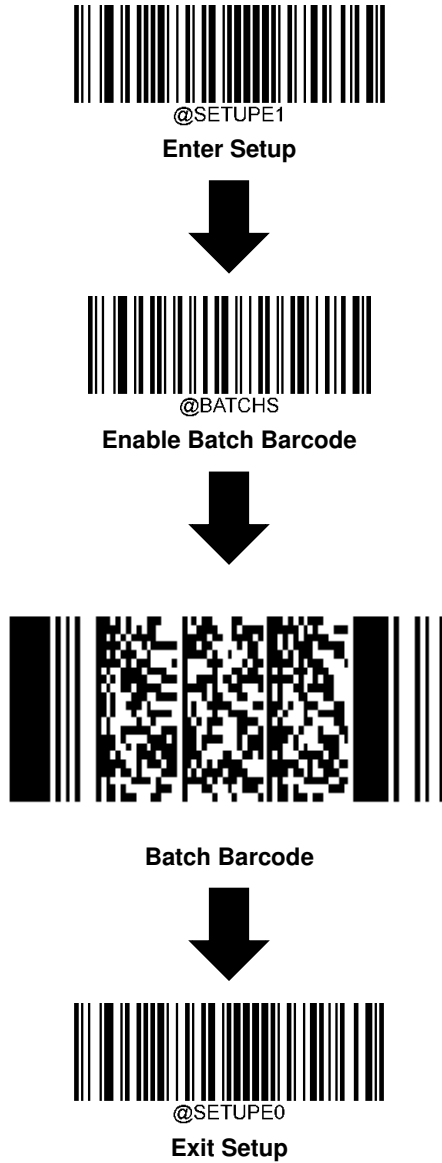

@SETUPE0  
\*\* Exit Setup

# Appendix

## Digit Barcodes

0~9



@DIGIT0

0



@DIGIT2

2



@DIGIT4

4



@DIGIT1

1



@DIGIT3

3



@DIGIT5

5



@DIGIT6

6



@DIGIT7

7



@DIGIT8

8



@DIGIT9

9

---

**A~F**



@DIGITA

**A**



@DIGITB

**B**



@DIGITC

**C**



@DIGITD

**D**



@DIGITE

**E**



@DIGITF

**F**



---

## Save/Cancel Barcodes

After reading numeric barcode(s), you need to scan the **Save** barcode to save the data. If you scan the wrong digit(s), you can either scan the **Cancel** barcode and then start the configuration all over again, or scan the **Delete the Last Digit** barcode and then the correct digit, or scan the **Delete All Digits** barcode and then the digits you want.

For instance, after reading the **Maximum Length** barcode and numeric barcodes “1”, “2” and “3”, you scan:

- ✧ **Delete the Last Digit:** The last digit “3” will be removed.
- ✧ **Delete All Digits:** All digits “123” will be removed.
- ✧ **Cancel:** The maximum length configuration will be cancelled. And the scanner is still in the setup mode.



@DIGSAV

**Save**



@DIGCAN

**Cancel**



@DIGDEL

**Delete the Last Digit**



@DIGDAL

**Delete All Digits**

## Factory Defaults Table

Parameter	Factory Default	Remark
<b>System Settings</b>		
Barcode Programming	Disabled (Exit Setup)	
Programming Barcode Data	Do not transmit	
Illumination	Normal	
Aiming	Normal	
Good Read LED	On	
Good Read LED Duration	Short (20ms)	
Power On Beep	On	
Good Read Beep	On	
Good Read Beep Duration	Medium (80ms)	
Good Read Beep Frequency	Medium (2730Hz)	
Good Read Beep Volume	Loud	
Scan Mode	Sense Mode	
Decode Session Timeout	3,000ms.	1-3,600,000ms; 0: Infinite
Image Stabilization Timeout (Sense Mode)	200ms	0-3,000ms
Reread Timeout	Disabled, 1,500ms	1-3,600,000ms
Reread Timeout Reset	Off	
Image Decoding Timeout	500ms	1-3,000ms
Good Read Delay	Disabled, 500ms	1-3,600,000ms
Trigger Selection (Sense Mode)	Both	
Image Change Trigger Sensitivity	Medium Sensitivity	
IR Proximity Trigger Sensitivity	High Sensitivity	
Trigger Commands	Disabled	
Scanning Preference	Normal Mode	
Decode Area	Whole Area Decoding	
Specify Decoding Area	40% top, 60% bottom, 40% left, 60% right	
Image Flipping	Do Not Flip	
Bad Read Message	Off	
	NG	1-7 characters
Default Interface	USB HID Keyboard	
<b>RS-232 Interface</b>		
Baud Rate	9600	

Parity Check	None	
Data Bits	8	
Stop Bits	1	
Hardware Auto Flow Control	Disabled	
<b>USB Interface</b>		
USB Country Keyboard	US keyboard	USB HID Keyboard
Beep on Unknown Character	Off	USB HID Keyboard
Emulate ALT+Keypad	Off	USB HID Keyboard
Code Page	Code Page 1252 (West European Latin)	USB HID Keyboard
Unicode Encoding	Off	USB HID Keyboard
Emulate Keypad with Leading Zero	On	USB HID Keyboard
Function Key Mapping	Disable	USB HID Keyboard
Inter-Keystroke Delay	No Delay	USB HID Keyboard
Caps Lock	Caps Lock OFF, non-Japanese Keyboard	USB HID Keyboard
Convert Case	No Case Conversion	USB HID Keyboard
Emulate Numeric Keypad 1	Off	USB HID Keyboard
Emulate Numeric Keypad 2	Off	USB HID Keyboard
Fast Mode	Off	USB HID Keyboard
Polling Rate	4ms	USB HID Keyboard
Adaptive Wired Communication	On	
<b>Symbologies</b>		
<b>Global Settings</b>		
1D Twin Code	Single 1D Code Only	
Surround GS1 AI's with Parentheses	Do Not Surround GS1 AI's with Parentheses	
<b>Code 128</b>		
Code 128	Enabled	
Maximum Length	48	
Minimum Length	1	
<b>EAN-8</b>		
EAN-8	Enabled	
Check Character	Transmit	
2-Digit Add-On Code	Disabled	
5-Digit Add-On Code	Disabled	
Add-On Code	Not Required	
Convert EAN-8 to EAN-13	Disabled	

<b>EAN-13</b>		
EAN-13	Enabled	
Check Character	Transmit	
2-Digit Add-On Code	Disabled	
5-Digit Add-On Code	Disabled	
Add-On Code	Not Required	
EAN-13 Beginning with 290 Add-On Code Required	Do Not Require Add-On Code	
EAN-13 Beginning with 378/379 Add-On Code Required	Do Not Require Add-On Code	
EAN-13 Beginning with 414/419 Add-On Code Required	Do Not Require Add-On Code	
EAN-13 Beginning with 434/439 Add-On Code Required	Do Not Require Add-On Code	
EAN-13 Beginning with 977 Add-On Code Required	Do Not Require Add-On Code	
EAN-13 Beginning with 978 Add-On Code Required	Do Not Require Add-On Code	
EAN-13 Beginning with 979 Add-On Code Required	Do Not Require Add-On Code	
<b>UPC-E</b>		
UPC-E0	Enabled	
UPC-E1	Disabled	
Check Character	Transmit	
2-Digit Add-On Code	Disabled	
5-Digit Add-On Code	Disabled	
Add-On Code	Not Required	
Transmit Preamble Character	System Character	
Convert UPC-E to UPC-A	Disabled	
<b>UPC-A</b>		
UPC-A	Enabled	
Check Character	Transmit	
2-Digit Add-On Code	Disabled	
5-Digit Add-On Code	Disabled	
Add-On Code	Not Required	
Transmit Preamble Character	No Preamble	
<b>Coupon</b>		
UPC-A/EAN-13 with Extended Coupon Code	Disabled	
Coupon GS1 DataBar Output	Disabled	

<b>Interleaved 2 of 5</b>		
Interleaved 2 of 5	Enabled	
Maximum Length	80	
Minimum Length	6	No less than 4
Check Character Verification	Disabled	
<b>Febraban</b>		
Febraban	Disabled	
Transmit Delay per Character	Disabled	
	70ms	
Transmit Delay per 12 Characters	Disabled	
	500ms	
<b>ITF-14</b>		
ITF-14	Disabled	
<b>ITF-6</b>		
ITF-6	Disabled	
<b>Matrix 2 of 5</b>		
Matrix 2 of 5	Enabled	
Maximum Length	80	
Minimum Length	4	No less than 4
Check Character Verification	Disabled	
<b>Code 39</b>		
Code 39	Enabled	
Maximum Length	48	
Minimum Length	1	
Check Character Verification	Disabled	
Start/Stop Character	Do not transmit	
Code 39 Full ASCII	Disabled	
Code 32 Pharmaceutical (PARAF)	Disabled	
Code 32 Prefix	Disabled	
Code 32 Start/Stop Character	Do not transmit	
Code 32 Check Character	Do not transmit	
<b>Codabar</b>		
Codabar	Enabled	
Maximum Length	60	
Minimum Length	2	

Check Character Verification	Disabled	
Start/Stop Character	Do not transmit	
	ABCD/ABCD	
<b>Code 93</b>		
Code 93	Disabled	
Maximum Length	48	
Minimum Length	1	No less than 1
Check Character Verification	Do Not Transmit Check Character After Verification	
<b>China Post 25</b>		
China Post 25	Disabled	
Maximum Length	48	
Minimum Length	1	
Check Character Verification	Disabled	
<b>GS1-128 (UCC/EAN-128)</b>		
GS1-128	Enabled	
Maximum Length	48	
Minimum Length	1	
<b>GS1 Databar</b>		
GS1 Databar	Enabled	
Application Identifier "01"	Transmit	
<b>EAN•UCC Composite</b>		
GS1 Composite	Disabled	
UPC/EAN Composite	Disabled	
<b>Code 11</b>		
Code 11	Disabled	
Maximum Length	48	
Minimum Length	4	No less than 4
Check Character Verification	One Check Character, MOD11	
Check Character	Transmit	
<b>ISBN</b>		
ISBN	Disabled	
Set ISBN Format	ISBN-10	
<b>ISSN</b>		
ISSN	Disabled	

<b>Industrial 25</b>		
Industrial 25	Disabled	
Maximum Length	48	
Minimum Length	6	No less than 4
Check Character Verification	Disabled	
<b>Standard 25</b>		
Standard 25	Disabled	
Maximum Length	48	
Minimum Length	6	No less than 4
Check Character Verification	Disabled	
<b>Plessey</b>		
Plessey	Disabled	
Maximum Length	48	
Minimum Length	4	No less than 4
Check Character Verification	Disabled	
<b>MSI-Plessey</b>		
MSI-Plessey	Disabled	
Maximum Length	48	
Minimum Length	4	No less than 4
Check Character Verification	One Check Character, MOD10	
Check Character	Transmit	
<b>AIM 128</b>		
AIM 128	Disabled	
Maximum Length	48	
Minimum Length	1	
<b>ISBT 128</b>		
ISBT 128	Disabled	
<b>Code 49</b>		
Code 49	Disabled	
Maximum Length	80	
Minimum Length	1	
<b>Code 16K</b>		
Code 16K	Disabled	
Maximum Length	80	
Minimum Length	1	

<b>COOP 25</b>		
COOP 25	Disabled	
Maximum Length	80	
Minimum Length	4	
Check Character Verification	Disabled	
<b>PDF417</b>		
PDF417	Enabled	
Maximum Length	2710	
Minimum Length	1	
PDF417 Twin Code	Single PDF417 Only	
PDF417 Inverse	Decode Regular PDF417 Barcodes Only	
Character Encoding	Default Character Encoding	
PDF417 ECI Output	Enabled	
<b>Micro PDF417</b>		
Micro PDF417	Disabled	
Maximum Length	366	
Minimum Length	1	
<b>QR Code</b>		
QR Code	Enabled	
Maximum Length	7089	
Minimum Length	1	
QR Twin Code	Single QR Only	
QR Inverse	Decode Regular QR Barcodes Only	
Character Encoding	Default Character Encoding	
QR ECI Output	Enabled	
<b>Micro QR Code</b>		
Micro QR	Enabled	
Maximum Length	35	
Minimum Length	1	
<b>Aztec</b>		
Aztec Code	Disabled	
Maximum Length	3832	
Minimum Length	1	
Read Multi-barcodes on an Image	Mode 1	
Character Encoding	Default Character Encoding	



Aztec ECI Output	Enabled	
<b>Data Matrix</b>		
Data Matrix	Enabled	
Maximum Length	3116	
Minimum Length	1	
Data Matrix Twin Code	Single Data Matrix Only	
Rectangular Barcode	Enabled	
Data Matrix Inverse	Decode Regular Data Matrix Barcodes Only	
Character Encoding	Default Character Encoding	
Data Matrix ECI Output	Enabled	
<b>Maxicode</b>		
Maxicode	Disabled	
Maximum Length	150	
Minimum Length	1	
<b>Chinese Sensible Code</b>		
Chinese Sensible Code	Disabled	
Maximum Length	7827	
Minimum Length	1	
Chinese Sensible Twin Code	Single Chinese Sensible Code Only	
Chinese Sensible Code Inverse	Decode Regular Chinese Sensible Barcodes Only	
<b>GM Code</b>		
GM	Disabled	
Maximum Length	2751	
Minimum Length	1	
<b>Code One</b>		
Code One	Disabled	
Maximum Length	3550	
Minimum Length	1	
<b>USPS Postnet</b>		
USPS Postnet	Disabled	
Check Character	Transmit	
<b>USPS Intelligent Mail</b>		
USPS Intelligent Mail	Disabled	
<b>Royal Mail</b>		

Royal Mail	Disabled	
<b>USPS Planet</b>		
USPS Planet	Disabled	
Check Character	Transmit	
<b>KIX Post</b>		
KIX Post	Disabled	
<b>Australian Postal</b>		
Australian Postal	Disabled	
<b>Specific OCR-B</b>		
Specific OCR-B	Disabled	
<b>Chinese ID Card OCR</b>		
Chinese ID Card OCR	Disabled	
<b>Passport OCR</b>		
Passport OCR	Disabled	
<b>Japan Post</b>		
Japan Post	Disabled	
<b>China Travel Permit OCR</b>		
China Travel Permit OCR	Disabled	
<b>Data Formatter</b>		
Data Formatter	Disabled	
Non-Match Error Beep	On	
Data Format Selection	Format_0	
<b>Prefix &amp; Suffix</b>		
All Prefixes/Suffixes	Disabled	
Prefix Sequence	Code ID+ Custom +AIM ID	
Custom Prefix	Disabled	
AIM ID Prefix	Disabled	
Code ID Prefix	Disabled	
Custom Suffix	Disabled	
Data Packing	Disable Data Packing	
Terminating Character Suffix	Disabled	

## AIM ID Table

Symbology	AIM ID	Possible AIM ID Modifiers (m)
Code 128	]C0	
GS1-128 (UCC/EAN-128)	]C1	
EAN-8	]E4	
EAN-8 with Addon	]E3	
EAN-13	]E0	
EAN-13 with Addon	]E3	
UPC-E	]E0	
UPC-E with Addon	]E3	
UPC-A	]E0	
UPC-A with Addon	]E3	
Interleaved 2 of 5, Febraban	]Im	0, 1, 3
ITF-14	]Im	1, 3
ITF-6	]Im	1, 3
Matrix 2 of 5	]X0	
Code 39	]Am	0, 1, 3, 4, 5, 7
Codabar	]Fm	0, 2, 4
Code 93	]G0	
China Post 25	]X0	
AIM 128	]C2	
ISBT 128	]C4	
ISSN	]X0	
ISBN	]X0	
Industrial 25	]S0	
Standard 25	]R0	
Plessey	]P0	
Code 11	]Hm	0, 1, 3
MSI Plessey	]Mm	0, 1
GS1 Composite	]em	0-3
GS1 Databar (RSS)	]e0	
Code 49	]T0	
Code 16K	]K0	
COOP 25	]X0	

Symbology	AIM ID	Possible AIM ID Modifiers (m)
PDF417	]Lm	0-2
QR Code	]Qm	0-6
Aztec	]zm	0-9, A-C
Data Matrix	]dm	0-6
Maxicode	]Um	0-3
Chinese Sensible Code	]X0	
GM	]gm	(0~9)
Micro PDF417	]L0	
Micro QR	]Q1	
Code One	]X0	
USPS Postnet	]X0	
USPS Intelligent Mail	]X0	
Royal Mail	]X0	
USPS Planet	]X0	
KIX Post	]X0	
Australian Postal	]X0	
Japan Post	]X0	
Specific OCR-B	]o2	
Chinese ID Card OCR	]o2	
Passport OCR	]o2	
China Travel Permit OCR	]o2	

**Note:** “m” represents the AIM modifier character. Refer to ISO/IEC 15424:2008 Information technology – Automatic identification and data capture techniques – Data Carrier Identifiers (including Symbology Identifiers) for AIM modifier character details.

---

## Code ID Table

Symbology	Code ID
Code 128	j
GS1-128 (UCC/EAN-128)	j
EAN-8	d
EAN-13	d
UPC-E	c
UPC-A	c
Interleaved 2 of 5, Febraban	e
ITF-14	e
ITF-6	e
Matrix 2 of 5	v
Code 39	b
Codabar	a
Code 93	i
China Post 25	X
AIM 128	X
ISBT 128	X
ISSN	g
ISBN	B
Industrial 25	l
Standard 25	f
Plessey	n
Code 11	H
MSI Plessey	m
GS1 Composite	y
GS1 Databar (RSS)	R
Code 49	X
Code 16K	X
COOP 25	X
PDF417	r
QR Code	s
Aztec	z
Data Matrix	u

---

---

Symbology	Code ID
MaxiCode	x
Chinese Sensible Code	h
GM Code	x
Micro PDF417	R
Micro QR	X
Code One	X
USPS Postnet	P
USPS Intelligent Mail	M
Royal Mail	x
USPS Planet	L
KIX Post	K
Australian Postal	A
Japan Post	J
Specific OCR-B	S
Chinese ID Card OCR	S
Passport OCR	O
China Travel Permit OCR	S

---

---

## Symbology ID Number

Symbology	ID Number
Code 128	002
GS1-128 (UCC/EAN-128)	003
EAN-8	004
EAN-13	005
UPC-E	006
UPC-A	007
Interleaved 2 of 5, Febraban	008
ITF-14	009
ITF-6	010
Matrix 2 of 5	011
Code 39	013
Codabar	015
Code 93	017
China Post 25	019
AIM 128	020
ISBT 128	021
COOP 25	022
ISSN	023
ISBN	024
Industrial25	025
Standard25	026
Plessey	027
Code11	028
MSI-Plessey	029
GS1 Composite	030
GS1 Databar (RSS)	031
PDF417	032
QR Code	033
Aztec	034
Data Matrix	035
Maxicode	036
Chinese Sensible Code	039

---

---

Symbology	ID Number
GM Code	040
Micro PDF417	042
Micro QR	043
Code One	048
Specific OCR-B	064
Chinese ID Card OCR	065
Passport OCR	066
China Travel Permit OCR	068
USPS Postnet	096
USPS Intelligent Mail	097
Royal Mail	098
USPS Planet	099
KIX Post	100
Australian Postal	101
Japan Post	102
Code 49	132
Code 16K	133

---



---

## ASCII Table

Hex	Dec	Char
00	0	NUL (Null char.)
01	1	SOH (Start of Header)
02	2	STX (Start of Text)
03	3	ETX (End of Text)
04	4	EOT (End of Transmission)
05	5	ENQ (Enquiry)
06	6	ACK (Acknowledgment)
07	7	BEL (Bell)
08	8	BS (Backspace)
09	9	HT (Horizontal Tab)
0a	10	LF (Line Feed)
0b	11	VT (Vertical Tab)
0c	12	FF (Form Feed)
0d	13	CR (Carriage Return)
0e	14	SO (Shift Out)
0f	15	SI (Shift In)
10	16	DLE (Data Link Escape)
11	17	DC1 (XON) (Device Control 1)
12	18	DC2 (Device Control 2)
13	19	DC3 (XOFF) (Device Control 3)
14	20	DC4 (Device Control 4)
15	21	NAK (Negative Acknowledgment)
16	22	SYN (Synchronous Idle)
17	23	ETB (End of Trans. Block)
18	24	CAN (Cancel)
19	25	EM (End of Medium)
1a	26	SUB (Substitute)
1b	27	ESC (Escape)
1c	28	FS (File Separator)
1d	29	GS (Group Separator)

---

Hex	Dec	Char
1e	30	RS (Request to Send)
1f	31	US (Unit Separator)
20	32	SP (Space)
21	33	! (Exclamation Mark)
22	34	" (Double Quote)
23	35	# (Number Sign)
24	36	\$ (Dollar Sign)
25	37	% (Percent)
26	38	& (Ampersand)
27	39	` (Single Quote)
28	40	( (Left/ Opening Parenthesis)
29	41	) (Right/ Closing Parenthesis)
2a	42	* (Asterisk)
2b	43	+ (Plus)
2c	44	, (Comma)
2d	45	- (Minus/ Dash)
2e	46	. (Dot)
2f	47	/ (Forward Slash)
30	48	0
31	49	1
32	50	2
33	51	3
34	52	4
35	53	5
36	54	6
37	55	7
38	56	8
39	57	9
3a	58	: (Colon)
3b	59	; (Semi-colon)
3c	60	< (Less Than)
3d	61	= (Equal Sign)

Hex	Dec	Char
3e	62	> (Greater Than)
3f	63	? (Question Mark)
40	64	@ (AT Symbol)
41	65	A
42	66	B
43	67	C
44	68	D
45	69	E
46	70	F
47	71	G
48	72	H
49	73	I
4a	74	J
4b	75	K
4c	76	L
4d	77	M
4e	78	N
4f	79	O
50	80	P
51	81	Q
52	82	R
53	83	S
54	84	T
55	85	U
56	86	V
57	87	W
58	88	X
59	89	Y
5a	90	Z
5b	91	[ (Left/ Opening Bracket)
5c	92	\ (Back Slash)
5d	93	] (Right/ Closing Bracket)

Hex	Dec	Char
5e	94	^ (Caret/ Circumflex)
5f	95	_ (Underscore)
60	96	' (Grave Accent)
61	97	a
62	98	b
63	99	c
64	100	d
65	101	e
66	102	f
67	103	g
68	104	h
69	105	i
6a	106	j
6b	107	k
6c	108	l
6d	109	m
6e	110	n
6f	111	o
70	112	p
71	113	q
72	114	r
73	115	s
74	116	t
75	117	u
76	118	v
77	119	w
78	120	x
79	121	y
7a	122	z
7b	123	{ (Left/ Opening Brace)
7c	124	(Vertical Bar)
7d	125	} (Right/ Closing Brace)
7e	126	~ (Tilde)
7f	127	DEL (Delete)

## Unicode Key Maps

6E	70	71	72	73	74	75	76	77	78	79	7A	7B	7C	7D	7E	•	•	•		
01	02	03	04	05	06	07	08	09	0A	0B	0C	0D	0F	4B	50	55	5A	5F	64	69
10	11	12	13	14	15	16	17	18	19	1A	1B	1C	1D	4C	51	56	5B	60	65	6A
1E	1F	20	21	22	23	24	25	26	27	28	29	2B				5C	61	66		
2C	2E	2F	30	31	32	33	34	35	36	37	39			53			5D	62	67	6C
3A	3B	3C	3D					3E	3F	38	40	4F	54	59	63	68				

104 Key U.S. Style Keyboard

6E	70	71	72	73	74	75	76	77	78	79	7A	7B	7C	7D	7E	•	•	•		
01	02	03	04	05	06	07	08	09	0A	0B	0C	0D	0F	4B	50	55	5A	5F	64	69
10	11	12	13	14	15	16	17	18	19	1A	1B	1C	2B	4C	51	56	5B	60	65	6A
1E	1F	20	21	22	23	24	25	26	27	28	29	1D				5C	61	66		
2C	2D	2E	2F	30	31	32	33	34	35	36	37	39		53			5D	62	67	6C
3A	3B	3C	3D					3E	3F	38	40	4F	54	59	63	68				

105 Key European Style Keyboard



# Newland

SCANNING MADE SIMPLE

---

Newland EMEA HQ  
+31 (0) 345 87 00 33  
[info@newland-id.com](mailto:info@newland-id.com)  
[newland-id.com](http://newland-id.com)

Need more info? Contact us or one of  
our partners at [newland-id.com/partners](http://newland-id.com/partners)